

Madison Area Jugglers' Pattern Book

Version 3.0

January 10, 2018

Contents

1 About this document	13
2 Hello Madison Club Passers and Friends!	15
How To Read Patterns	16
Counts/Cycles	16
Example: standard feed	16
Typewriter Extra Club Feed (13 clubs)	17
Some Funny Left/Right Box	17
Site Swaps	18
Secret Juggling Code Words and Phrases (Glossary)	18
Random Tips on Passing Patterns	19
Mastering the craft	20
Timing	20
Leads	20
Turning	20
Learning	21
Passing Pattern Philosophy	21
Mutate	21
Complicate	21
Combine patterns (<i>Mating</i>)	21
Stacking	21
Starting	22
Make it interesting	22
Internet Passing Resources	22
Version History	23

3 3-Person Patterns	25
Feed	25
Extra Club Feeds	25
Triangles	27
Rotating Feed	27
Pulsar	27
Puzzle and Variations	28
Three-piece Puzzle (for 2 jugglers)	28
Puzzle Feeder (for 3 jugglers)	28
Puzzle Feast	28
Siteswap Feeds	28
Extra Club Rotating Feed (for 3 jugglers)	29
Extra Club Triangles	29
10 Club 3 Count Triangle	29
11 Club 2 of 3 Count Triangle	30
12 Club 1-Count Triangle	30
10 Club Triangle with Triple-Single-Single	30
6-Count Popcorn Triangle	31
5-Count Popcorn Triangle	31
10 Club 4-Count Triangle	31
Lines	31
Mel in the Middle	32
Dropback Line	32
Line Feed	32
Extra Club Line	32
Turbos	33
Bruno's nightmare	33
Turbo (standard)	33
Count and Hand Variations	34
10-Club Turbo	34
Another 10-Club Turbo	35
GDP	36
Laura's Weave	36
$2\pi/3$	36
Up-Up-Over	37
Graham's 3 stuff	38

Change Sides Double-3 Count Feed Plus	38
Change Sides RRLRLRLLRL	39
Safe Beast of Arg	40
4 4-Person Patterns	41
Boxes	41
Basic 4-Count Box	41
2-Count Box	41
1-Count Asynchronous Box	42
Extra Club Boxes	42
14-Club Ultimate Box	42
Bermuda Quadrangle	43
Maya	43
Interlocking Triangles	43
Spider Web	44
Extra Club Rotating Feed (for 4 jugglers)	44
Gustav	44
Switch Sides Feed	45
Windshield Wiper Switch Sides Feed	45
Typewriter Switch Sides Feed	45
Extra Club Switch Sides Feed	46
Weaves	46
Standard Weave	46
5-Count Weave: Feeder PSPSP=5/3-Count, Feedees 5-Count	48
Double 3-Count Weave: Feeder 3/2-Count, Feedees 4-then-5-Count	48
Hyper-Weave: Feeder 1-Count, Feedees 3-Count	48
Dresser-Drawer Weave	49
Inside-Out Weave	50
It's a Good One	50
Gandini Weave	50
Three Leaf Clovers	51
Standard Clover	51
Run Over Clover	52
Extra-Club Three Leaf Clover	53
Hyper-Clover	54
Mike's Original Clover	54
Peter's Clover	55

Steve's Clovers	55
Spinny patterns	57
Benzene Ring (Four Juggler Version)	57
Chocolate Stir	57
2 π /3 With Post	58
Canoe	58
Death from Above	58
Two-on-Two Double 3-Count	59
Ultimate Feeds	59
12 club standard 1-count feeds	59
Ultimate Feed Plus	60
Ultimate Feed Plus Plus	60
El Nino	60
El Nino Plus	62
Slow Version	62
Fast Version	62
El Turbo	63
Tomahawk	64
Oogle Boogies	64
Original Oogle Boogie	64
Fast Oogle Boogie	65
14 Club Oogle Boogie	65
Luke's Oogle	65
Slingshot	66
Martin's Madness/Mildness	67
Popcorn Feed	68
Low Popcorn Feed	68
Popcorn Weave	68
Simple Egg Beater, No Handle	69
Unicycle	69
12 club	69
Unicycle Plus	70
Y2K	71
Gorilla for Four	71
Anklet (for 4 jugglers)	72
Rush and Rest	72

Classic Rush and Rest	72
First Variation	72
Second Variation	73
Shooting Star	73
14 Club Lines (for 4 jugglers)	74
Locked Lines	74
Popcorn Lines	74
Popcorn Lines 2	74
Popcorn Dropback Line	75
Popcorn Dropback Line 2	75
Popcorn Dropback Line 3	75
5 5-Person Patterns	77
Apollos	77
Original Apollo	77
Cockeyed Apollo	77
Apollo Plus	78
Apollo Plus Weave	78
Chocolate Feeds	78
Chocolate Bar 3-Count Feed	78
Double Chocolate Double 3-Count Feed	79
Semi-Sweet Chocolate 3-Count Feed	79
Circles	80
Feast (for 5 jugglers)	80
Extra Club Rotating Feed	81
Extra Clubs Feast	81
Basic Star	82
Selfless Star	83
Feast-Star	83
Extra-Club Stars	83
Triply Star	85
20 Club Star	85
Twirly Star	85
Up-Up-Over-5	86
Gauntlet	86
Mr. Inside-Mr. Outside Weave	87
Twister Weaves	88

Original Twister Weave	88
PSPSP Twister Weave	89
3-Count Twister Weave	89
Fast Twister Weave	90
Ultra-Twister Weave	90
Hyper-Twister Weave	90
Twister Plus	91
Double Time Twister	91
Double Time Twister Plus	92
Twister Popcorn	92
Twister Popcorn Weave	93
Four-Leaf Clover	93
Chocolate Swirl	95
Mango Swirl/Mangled Squirrel	95
Egg Beaters	96
Original Egg Beater	96
Martin Frost's Variation	97
Luke's Egg Beater Plus	97
3-4-5 Egg Beater	98
Egg Beater, Handle in the Batter	98
Egg Beater, Switching Handles	99
Strange Attractor / Estranged Tractors	100
Whirling Melvish	101
Cathedral	102
Quincunx	103
Ivy- π weave (read ivy pi weave)	104
El Turbo plus one post	104
6 6 Person Patterns	105
1-2-3 Apollo	105
Feast	105
Argyles	105
Argyled Triangles	105
Argyle Sock	106
Hex	107
Bubbler of David	107
6-Person Double Weaves	108

Standard Double Weave	108
Invert Prevert Weave (Equidistant Weave)	108
Cross-Corner Weave (Kitty-Korner Weave)	109
Extra-club Double Weave	109
Dresser Drawers Double Weave	109
Switch Sides Double Weave	109
Double Gandini Weave	110
Double Gandini Weave Plus	110
Stick on the End Double Weave	110
Five Person Weave (Peter Feeds Five)	111
Spiral	112
Standard 5-Weave	113
Gandini 5 Weave	113
Twister 4 Weave	114
Foie-Graham	115
6-Person Turbo Variations	116
Interlocking Turbos	116
Back to Back Turbos	117
Ball Bearing	118
Benzene Ring (6 person)	119
Benzene Ring Plus	119
Double-Handled Egg Beater	120
Razor	120
Electric Razor	121
Two-Seated Unicycle	121
Mel's Big Woody	122
Trompe L'oeil (Concentric Triangles)	123
Overlapping Y's	124
More Mating Oogles	124
Fireworks	125
Theatre Style Popcorn	125
Windy Two Holer	126
El Turbo Plus Two Posts	127
Ivy- π Weave Plus Post	127
Four Leaf Clover plus Orbiter	127

7	7 Person Patterns	129
	Feast	129
	1-2-4 Apollo	129
	Hinge	130
	Overlapping Chocolate Bar 3-count Feeds	130
	Open Face Sandwich	130
	The Blast	131
	Broken Hearted Blast	132
	Wonky Benzene Ring	132
	Twister-5's	132
	Original Twister-5	132
	Double Time Twister 5	132
	Twister-5 Plus	133
	Twister-5 7-then-8-Count	133
	Twister-5 5-Count	133
	Twister-5 Sandwich	133
	Twister Plus Plus	133
	Iron Cross Weave	134
	Intersecting Weave	135
	Eye of the Needle	136
	2-5 or 1-5-1 Foie Graham	136
	Big Mangled Squirrel	136
8	8 Person Patterns	137
	Feast	137
	4-on-4 line	137
	Double vision 4's	137
	Big Hinge minus 4	137
	Polymer Weave	137
	Benzene Rings (for 8 Jugglers)	138
	Original	138
	Inverted Extra Club Benzene Ring.	139
	Khaos Butterfly	139
	Egg Beater Twister	140
	Original	140
	Everyone Moves	141
	3-5 Foie Graham	141
	Two Mating Three Leaf Clovers	142

9	9 Person Patterns	143
	Feast	143
	Big Hinge minus 3	143
	Twister Sandwiches	143
	Original Twister Sandwich	143
	Twister Sandwich Variations	144
	Weaving Canoes	145
	Weaving Triangles	145
	Triangle of Weaves	146
	Stacks	146
	1-2-3-2-1	146
	1-3-4-1	146
10	10 Person Patterns	147
	Feast	147
	5 on 5 lines	147
	Double-vision 5's	147
	Big Hinge minus 2	147
	Double Weave (with 10 jugglers)	148
	Double Gandini 5 Weave	148
	Double Blast	149
	Two Mating Four Leaf Clovers	150
11	Big Patterns	151
	Big Hinge	151
	Precious Metal Hinge	152
	Double Vision Hex	152
	Fully Loaded Blast	152
	Double-Decker Sandwich	153
	Triangle Weave	153
	Octagon Weave	155
	Mating Clovers	156
	Big Circle	157

12 Luke's Extras Plus More from Graham	159
Dual Passing Patterns	159
Dual Passing Pattern for 4	160
Dual Passing Pattern for 2	161
Gandini Siteswap Weaves	161
7 Club Patterns	162
7 Club 2-Count Exposed	164
Synchronous Passing	166
Passing 43	168
More Patterns by Graham	170
6 Club Dingle	171
7 Club Dingle	171
7 Club Martins	172
Hard 4 Person With Easy Positions	173

Chapter 1

About this document

All jugglers are welcome to play with, use, distribute, extend, and otherwise enjoy all the club-passing patterns described in *Madison Area Jugglers' Pattern Book, Version 3.0*, which is licensed by its creators, the Madison Area Jugglers, under the Creative Commons Attribution 3.0 Unported License¹ .

To see the book online (I mean, if you're not already reading this on a computer!), use this QR code:



or visit the *Madison Area Jugglers website*² for other links to this document and cool stuff about the MAJ. All the code to make (and update!) this collection is at a *Github repository*³. See the *build* subdirectory for the current pdf file. Thinking it would facilitate expansion and easy inclusion of new patterns, we formed the source code for this document as a collection of simple markdown files, including image media as appropriate. New contributions are welcome for the next version, so please visit the Github site and provide some pattern descriptions.

If you have any questions, comments or suggestions relating to this book, please contact the Madison Area Jugglers. Where possible we have given credit to the creators of the patterns described here, though for many these origins were unknown to us. If we have erred in our attributions, please let us know.

¹http://creativecommons.org/licenses/by/3.0/deed.en_US

²<http://madjugglers.com>

³<https://github.com/wiscstatman/pattern-book>



Chapter 2

Hello Madison Club Passers and Friends!

Welcome to the *Madison Area Jugglers' Pattern Book*, a collection of patterns for intermediate to advanced passers. These patterns are part of our juggling repertoire. Many we learned or adapted from other jugglers; we include them because it's fun trying to juggle them. But very many of the patterns in this book were born in Madison, conjured up at Thursday/Sunday juggling sessions or at 47th Annual Madfests, annual events since 1992. The book offers some record of the evolution of club passing in Madison.

Originally we wrote down the patterns just to save time arguing over exactly how we did the pattern last time. (Don't worry... there's still plenty of arguing, even with the book.) We were pleasantly surprised to find other people found our book helpful too! The pattern book can be used as a club passing guide or just a library of the patterns that we originated or find interesting. If you're from Madison, then it's a handbook to what we do twice a week on Thursdays and Sundays, and if you don't know the patterns already then you probably will. This book is not intended to be an encyclopedia of all possible passing patterns (that would be a big book)! In fact, we don't include patterns just because they are *theoretically* possible; we include them if we have done them!

The Madison Area Jugglers (MAJ) have been attempting, inventing, and recording juggling patterns for longer than most of us can remember. In 1997, when our memories were already getting strained by the variations, Mike Newton compiled our first *Pattern Catalogue* to record the patterns for four or more jugglers. This morphed into the first *Pattern Book* by January 1999, but the hand-written collection (*Version 0.1*) was in a pretty limiting format. By October of that year, Steve Otteson created the first computerized collection by reformatting and expanding Mike's hand-written notes. Melonhead still carries around a tattered printout of *Version 1.0*. Steve made a few version updates, for example adding a bunch of extra-club patterns by Peter Kaseman and Luke Emery; the unusual computer format of Steve's version and his departure from Madison slowed down subsequent updates, even though the MAJ continued to create new patterns at a steady rate. The next big contribution was Luke Emery's version (*Version 2.0*, 2012). Though it was not widely distributed, Luke's version contained all kinds of new additions: more patterns for all numbers of jugglers, more on site-swap, more on specialized extra-club patterns, and tips for creating and doing patterns. In 2015 Matt Hemke and Evan Driscoll created a Github repository for the project, converted Luke's version into a repo, and updated the collection further.

Recently Chan Wilson, Jeff Adamus, and Melonhead have been recording the patterns we do at Thursday and Sunday MAJ practices. It's an amazing collection, and for those who remember the code words, like *1-5-1 Foie Graham* or *4-5 Twister*, it's enough to figure out what we really did. But most of us forget the code words after a while, except for the frequently juggled ones, and this has been an impetus for this Version 3.0 update by Mike Newton. All along the editors have had substantial input from the Madison Area Jugglers and friends, and we are indebted to them for helping enhance this collection. Club passing is a social pastime that needs a group of similarly inclined jugglers. Many of these patterns are inspired by other jugglers and

patterns or created in collaboration with other jugglers. We hope that these patterns will help inspire new club passing ideas and help more jugglers all over the world enjoy club passing!

How To Read Patterns

There seems to be an indefinite number of ways a single juggler can juggle, so it's not surprising that a juggling *pattern*, which combines the efforts of multiple jugglers, can also take many many forms. There are many exceptions – and we cover a lot of them – but to develop our intuition it's convenient to start with standard formulations. Say each juggler is throwing three clubs, alternating hands *right-left-right-left* etc, and juggling in sync with the others (all doing *right-left-right-left*...). In this standard formulation, passes are single-spin exchanges between jugglers, either right-to-left or left-to-right throws. Even without adding extra clubs or unusual throws (heff's, zips, simuls), there is an incredible variety of fun patterns found by varying where jugglers are and who passes to whom when.

Counts/Cycles

A basic passing descriptor is the *count*, which tells the juggler how frequently to make a pass. In simple patterns each juggler's count is constant, but even simple patterns can be very difficult on a fast count. We say you are passing on an m/n -count if you make n passes in a cycle of m beats, counting on both hands. For example, $2/1$ -count means, *pass-self*, then repeat. When the denominator n is 1 we just say m -count, as in the familiar 1-count, 2-count, 3-count, and so on. Double-three count is a popular count, which in this notation is $3/2$ -count. Stating the count does not necessarily imply what hands are doing what, how many clubs are being juggled, or the starting configuration. E.g., left-hand 2-count is different from right-hand 2-count. Odd counts (i.e., odd m) are nicely balanced for the hands; then the only issue is the start, which we usually do out of the right.

Mortal jugglers, like us, can only do patterns that repeat. That repeatable unit is called a *cycle*, and it takes some total number of beats to complete on whatever is the base count of the pattern. Patterns with longer cycles are usually harder to remember and therefore harder to do, but not always. In many patterns each juggler does something relatively simple (i.e., a shorter *local* cycle) even if the whole pattern takes a long time to complete. Those are cool!

Throw timing, throw destination, and juggler position over time have to be recorded to describe a juggling pattern. We use tables and figures to express this information. For example, the table below (right) describes a standard feed, with jugglers (letters) on the rows and passing beat (numbers) on the columns. We sometimes reverse row and column for complicated (longer-cycle) patterns. We often accompany the table with a simple figure showing how the jugglers are positioned (left). In moving patterns (later) we also indicate positions and transitions with a nodes-edges graph.

Example: standard feed

	Juggler/beat	1	2	3	4
A	A	B	C	D	C
B	B	A			
C	C		A		A
D	D			A	

A

B C D

positions

Right-hand counting

The label “Right-hand counting” means that only the right-hand throws are tabulated. The column under each number lists the jugglers that pass at that time. Since left-hand passes are not made in this particular pattern, they are not tabulated; self-throws are indicated with a blank entry.

For example, if I was juggler C in the above pattern, I would read along the 3rd row to see where I pass. On the first pass (column 1), I have a self throw (the empty box represents a self throw). For the next right-hand throw (column 2), I pass to A. For the next two right-hand throws, I do a self throw followed by a pass to A. The table rolls over, so that the fifth pass is the same as the first; i.e. the pattern has a 4-beat cycle.

Unless otherwise specified, all passes are single spins and do not cross. Doubles and triples to juggler A would be indicated by D-A and T-A respectively and are also straight unless noted.

Special instructions like different counts, double selves, crossing passes or starting instructions may be noted in or below the table.

Typewriter Extra Club Feed (13 clubs)

Juggler/beat	1	2	3	4	5	6
A	D-D		D-C		D-B	
B		D-A				
C				D-A		
D						D-A

- Both hands counting, right hand passes.
- A starts with 4 and right hand
- B, C and D start with left hand

Here’s an example with double straight passes and special instructions. In this case all the passes are right-handed passes, but we count both left and right-hand throws. A throws right Double pass to D, then left self, then right Double pass to C, then left self, then right Double pass to B.

How to tip: Jugglers C and D should throw a little higher and deeper so A has room to pass underneath to C and B.

Some Funny Left/Right Box

Juggler/beat	1	2	3	4	5	6
A		B C	B		D	
B		A D	A		C	
C			A	D	B	D
D			B	C	A	C

- Both hands counting

The above pattern has both hands counting, so the column under 1 is a right hand pass, the column under 2 is a left hand pass, etc.

If I was juggler D, I will read the fourth row to see that I start with a right hand self (column under 1), followed by a left hand pass to B (column under 2). The next 4 throws are: right hand self, left hand pass to C, right hand pass to A, and a left hand pass to C. then the pattern repeats.

Any variation to anything said above will be noted as needed when a pattern requires special circumstances.

Site Swaps

Occasionally we tap the wonderful world of site-swap notation¹ to describe patterns. For example, 7 club 2-count is 4p 3 | 3 4p (2nd juggler starts with left hand). There are a number of different site swap notations out there for passing. We use whatever seems to make sense to us at the moment and make no guarantee of consistency!

Secret Juggling Code Words and Phrases (Glossary)

- **baby position.** The least challenging task in a juggling pattern, if there is one.
- **Bernardos.** Unnecessary solo juggling tricks performed while other jugglers are trying to start a pattern. Named after Paul Bernardo, an expert of the craft.
- **Canadian catch.** An impressive catch that would have been difficult for most mortal jugglers.
- **carriage return.** A style of feeding where the feeder returns to the first feedee in the line after passing in sequence to all feedees. (also called typewriter)
- **chalant.** To drop a perfectly fine pass due to lack of focus. The opposite of nonchalant.
- **chocolate bar.** pass-pass-self-self; a 4/2-count. By convention, this starts with the right-hand pass.
- **cross.** A left-to-left or right-to-right pass.
- **cycle.** The amount of juggling after which the pattern repeats.
- **Doc Blanchard/Glenn Davis.** Mr. Inside/Mr. Outside.
- **double 3-count.** pass-pass-self: Academics insist that this is a 3/2-count not 2/3-count.
- **encroachment.** Premature lane-crossing between two passing jugglers in a moving pattern. Usually entails a 5-yard penalty.
- **everies.** 2-count
- **every-others.** 4-count
- **exclusion principle.** No two jugglers can occupy the same place at the same time.
- **extra clubs.** When the number of clubs for the pattern exceeds three times the number of jugglers.
- **feast.** A pattern having only feeders, usually arranged in a circle.
- **feed.** A passing configuration where one juggler passes to multiple others.
- **feedee.** One who passes with a feeder.
- **feeder.** One who feeds. Usually this juggler is stationary.
- **hup.** The vocalization that signals the end of the pattern.
- **immaculate assumption.** When you think that a juggler is about to move or pass... maybe they even give you the look... you know, the **look**... but then they don't!
- **inverted.** A moving convention in the weave: forward-on-the-end/back-through-the-middle
- **I blame society.** An excuse for some juggling failure (usually by Mel).
- **last jugglers' try.** The last attempt at a pattern, but only if it goes well enough.
- **leader.** One who calls out, *jugglers ready: up, down, ...* at the beginning of a pattern.
- **Mel catch.** The act of catching the fat end after a 2.5 triple up.
- **Mr. Inside/Mr. Outside.** The two feeding positions of a doubly-fed weave.
- **mustard.** Energy, power, spice, velocity or chi added to throws. As in, "Your corner passes need more mustard." Also, crispy. The opposite of mustard is mayonnaise.
- **NFP.** Nice Pass.
- **No, this is a club.** Said while pointing to a juggling club and talking to a curious passer-by who asks about the group, "Is this a club?"
- **olive.** In a stacked, sandwich-style pattern, a single feeder on one side of the pattern.
- **orbiter.** A juggler who orbits a standard moving pattern and passes to others on some of their would-be self throws.
- **phantom.** A feedee place holder who isn't really there. A feeder, for example, may feed 2 real feeders and a phantom in a sweep feed: pass-pass-self-pass and repeat.
- **plus.** A suffix added to indicate an extra club added to the base pattern.

¹<https://en.wikipedia.org/wiki/Siteswap>

- **post.** A stationary orbiter.
- **preverted.** A moving convention in the weave: back-on-the-end/forward-through-the-middle.
- **run it.** Continue juggling for an indefinite number of cycles.
- **scheisse.** An utterance of frustration, possibly by Dan Schuchnect.
- **Someone passed me a bad self.** An excuse for dropping.
- **southern Wisconsin convention.** When changing sides from a feedee position in a standard count, do so on an outside-throw/inside-catch; e.g. on a right-hand throw/left-hand reception when on the right side of the feedee line.
- **straight.** A right-to-left or left-to-right pass.
- **sweenish.** A fancy final move in a pattern, preferably clean.
- **The wind is our friend.** An encouraging commentary when juggling outside.
- **three-count.** In Madison, the default passing count between two jugglers. Sometimes called the *waltz*.
- **tomify.** Replace a pass-self or a pass-self-self with pass-pass-pass to the same recipient. (thanks Tom Pomraning)
- **triple up.** The showy last action in a pattern, after the hup, in which each juggler lofts a triple self.
- **ultimate.** 1-count
- **walk it through.** To perform a slow-motion instance of a pattern, with juggling replaced by the holding of clubs, with passes replaced by pointing to where you would pass, and following a slow, deliberate count by the leader. Done while setting up a pattern in order for jugglers to figure out what the hell they are supposed to do.
- **weave.** A most popular moving pattern with three feedees and a feeder, which is the basis of many multi-person patterns. The 3 feedees move in a figure 8 while juggling.
- **windshield wiper.** The more common style of feeding where the feeder first feeds the line in sequence, and then returns in reverse order. Windshield wiper and carriage return are the same with two feedees, but differ for three or more feedees.
- **wuss.** The amount of gentleness, tenderness and love added to a juggling throw. Compare to mayonnaise. Also, the quality of passes you would make to your favorite grandmother. As in, "Please add some wuss to your middle passes. You're hurting my catching hand!"
- **You herniated my ZOC.** Said if a pass forced extension and excessive effort in the catching.
- **ZOC.** Zone of Catchability. The volume near a juggler in which successful catches are probable. Peter Kaseman has the largest ZOC in Madison.
- **ZOOS.** (sounds like the Greek god Zeus) Zone of occupied space. Space occupied by a moving juggler.

Random Tips on Passing Patterns

- **Better Never than Late.** If you miss a passing beat, don't pass on the next throw! Instead, wait for the pass to come around again in the pattern.
- **Always keep your eye on Mel.** Don't pick up the clubs until you're sure the pattern is over, unless you know you can pick up and keep juggling. Even when you're not juggling, it's wise to keep an eye on Mel.
- **Juggle slow, move fast.** You get it. There's a tendency to speed up your juggling when you move. Don't.
- **Juggling means never having to say you're sorry** No, really. Don't say you're sorry unless you draw blood. (However, if you draw blood then you do have to say you're sorry.) Beginners often apologize profusely for their lack of skill. It's ok! We already know you're a beginner. But we like passing with other people and passing with beginners too. You'll get better soon and the best way is with lots of passing! If people want to do a hard pattern that is too advanced for beginners then they will, and you'll be left out of that one. Just do a pattern with somebody else. If we're juggling with you it's because we want to, not because we have to. Most patterns have positions of varying skill requirements, so if you're a beginner in a bigger or more advanced pattern, we'll try to put you in the best spot for your level. Just try to do the best you can, and if you drop, try to keep the timing anyway.
- **Mike's the leader.** Unless he's not.
- **Throw global, catch local.** A prescription for happy passing.

Mastering the craft

Timing

It may already be obvious, but good timing is critical to group passing patterns. One of the best tools to keep timing is your ears. For most patterns, all the catches should happen at the same time. When the timing is perfectly synchronized the sound of catching clubs is a metronome for the pattern.

Otherwise, find a juggler in your field of vision and make sure you throw at exactly the same time as they do (either passes or selves).

Make sure all the passes of the same spin go to the same height.

For many patterns, selecting a juggler to count out loud as a metronome can be very helpful.

And follow the leader!

MAJ timing: We estimate 0.9 seconds per right hand beat for no-extra-club passing. This is a little slower than at most North American sites and a little faster than at some European sites!

Leads

The second most important skill is for the passer to lead the catcher in the direction they are moving. The amount of lead varies based on the height of the throw, the tempo of the juggling, and how fast the weaver is moving.

Outside leads are the easiest, because they are thrown away from the catcher's pattern.

Inside leads are trickier, because they are thrown towards the catcher's pattern, and if the passer is exchanging clubs with the catcher, the two passes are prone to collision. (For some patterns, such as the Cyclone, the weavers are moving so fast that the inside leads go all the way on the other side of the incoming pass.)

One key to throwing good leads is to be able to see where your passes land. That's a difficult skill at first, and especially hard for some patterns with high throws, but your target will certainly appreciate the effort. Otherwise, good communication (especially for dropbacks or other blind passes) helps fine tune lead throws.

Remember that in a feed, the feedee on the same side as the feeder's pass must throw an inside and/or deep pass to give the feeder room to throw underneath to the next feedee.

Turning

Twister weaves are all about turning. In general you can classify how hard a moving pattern is by how many selves are allocated to turn 180 degrees. For example, the Standard Twister Weave has 5 selves (weaving in 6-count). The Fast Spiral has 3 selves (weaving in 4-count). The Chocolate Swirl has 1 self (crossing sides in double 3 count).

In most of these patterns you can turn either to the outside or the inside. One turn is usually easier than the other, but I recommend jugglers learn both turns whenever possible. Learn turning in easy patterns like the Twister Weave and then you can apply those to Clovers or Strange Attractors and other more advanced weaves.

It is also helpful to practice turning while juggling solo. How many selves does it take you to turn 180 degrees while spinning continuously?

Learning

Take advantage of opportunities to pass with jugglers better than you. That's how you'll learn timing.

Take advantage of opportunities to pass with jugglers less skilled than you. That's how you'll learn catching.

Be sure to pass with jugglers at the same level as you. That's how you know how good you really are. :)

Lots of passing patterns benefit from solo skills too. You'll need to be able to juggle 4 clubs comfortably in triple singles, double singles and the fountain to do a lot of the 7 and 8 club based passing patterns.

Passing Pattern Philosophy

We're occasionally asked at juggling conventions, where do you come up with all these patterns? Actually, they sort of make themselves once you invite the opportunity. Here are some tips on how to make new passing patterns and have fun doing it. We discuss some other pattern generation techniques in Chapter 12.

Mutate

- Start with a classic juggling pattern or any geometric figure (box, triangle, star, Y, W, line, etc.).
- Think about everybody juggling 3 or 4 clubs.
- Replace any selves with a pass to another juggler doing a self.
- Switch the positions of jugglers, but retain the passing sequence.
- Try the same movement in a different count, or left handed.
- Try the same passing sequence in a different movement.

Complicate

Why not make things harder? You get better at basic patterns if you try harder variations; plus they can be interesting if they're not too hard. (We estimate that a success rate of 1/3 is optimal for making progress and retaining interest!)

- Replace any 3-count with a double 3-count.
- Replace any feed with an extra club feed.
- Replace any extra club feed with a 2 extra club feed.
- Make stationary jugglers move (circles, clovers, figure eights, or any juggling siteswap just to name a few).
- The clubs can be passed in any juggling pattern or siteswap (admittedly, patterns get challenging quickly once you get past the easier siteswaps).

Combine patterns (*Mating*)

- Replace any position with a set of jugglers that spits out that same count. E.g. replace one person doing a 4-count with one side of a Twister Weave; or replace a 2-count person with a Weave (assuming there is room!). This is the source of many fun big patterns, such as the Egg-Beater-Twister.

Stacking

- Weaves-of-three and spinning-pairs are pattern components that emit passes on either side of a line. They are naturally combined into multi-layer patterns by stacking them up against each other in parallel.

Then feeders (sometimes called *olives*) or same-facing movers anchor either end of the stack. We get simple descriptors for quite elaborate patterns, such as 1-2-3-2-1, or 1-2-2-2-2-1. (See later chapters for more details.)

Starting

- There's nothing that saps mojo more than a long discussion about how to start or progress through a pattern. Keep instructions simple, informative, and clear. Warm up by doing parts of a pattern in isolation. Walk it through and minimize the Bernardos.
- For very big patterns, we use two decks of playing cards: one is used to mark starting positions by taping cards to the floor; a matched set from the second deck is handed out to the participants. The leader just instructs jugglers to find their positions, and they usually self-organize! We also use tape on the floor to mark movements or passing lanes to keep it clear.

Make it interesting

- Many of our favorite patterns are group collaborations where lots of people gave ideas for new ways to move or pass.
- Share your favorite club passing patterns with other jugglers and listen to their ideas too.
- Recognize the skill level of your participants and do patterns in which everyone can be challenged while also having fun.
- Antonio Vivaldi, in 1725, titled his Opus 8, 12 Concerti for chamber orchestra and violin: *Il cimento dell'armonia e dell'inventione*, or, *The contest between harmony and invention*. There's no evidence he was juggling, but there is a connection to our endeavor. To be worked on, a juggling pattern has to be sufficiently novel that it is interesting for the participants to engage in, but also sufficiently regular that it can be mastered with reasonable effort. The fact that the Pattern Book has grown is testament to the fact that jugglers regularly pass clubs in Madison; for this activity to persist there must be invention of new things; and as well there must be consistent elements – count signatures or motion elements – that we master and then recombine in interesting and enjoyable ways.

Internet Passing Resources

The world of juggling has many contributors and contributions that we have failed to identify in this collection. Some important ones are:

- Flying Karamozov Brothers²
- Gandini Juggling Project³
- Martin Frost's Youtube channel⁴
- JiBe's passingDB site⁵
- International Juggling Association site⁶
- Will Murray's site⁷
- Mark Weston's passing collection⁸

²<http://www.fkb.com/>

³<http://www.gandinijuggling.com/>

⁴<https://www.youtube.com/user/elgra2>

⁵<https://www.passingdb.com/>

⁶<http://www.juggle.org>

⁷<http://www.csulb.edu/~wmurray/>

⁸<http://www.varietyartsdirectory.com/resources/PassingPatternsAug06.pdf>

Version History

- Madison, Wisconsin, January 1999 Version 0.1
- Madison, Wisconsin, October 1999 Version 1.0
- Madison, Wisconsin, January 2001 Version 1.1
- Madison, Wisconsin, March 2001 Version 1.2
- Madison, Wisconsin, January 2012 Version 2.0
- Madison, Wisconsin, January 2018 Version 3.0

Like all earlier versions, the current Version 3.0 contains mistakes and unfortunate omissions, which we have yet to discover and for which the Editor's take responsibility. We hope that future versions will correct these shortcomings.

Chapter 3

3-Person Patterns

Big patterns come from little patterns, so we need to know some of these first!

Feed

The feed for 3 jugglers is the simplest 3 person pattern and likely the first one you tried. Because juggling with 3 is so much different than with 2, it's often a good idea to be comfortable with other patterns in a 3 person feed before trying them in larger patterns.

A B C	Juggler/beat	1	2
	A	B	C
	B	A	
	C		A
positions	Right hand counting		

How about left handed, chocolate bar, feeder in double 3-count (and feedees in 3-count), or Tom's (which is 3 passes in a row to each feedee with no selves for the feeder)?

Extra Club Feeds

Then extra club 2-count feeds with 10, 11 and 12 clubs (in singles and doubles and triples). There are 4-count feeds in triples and popcorn feeds in 5-count, 6-count and 7-count. And 7 club double 3-count feeds in pass, pass, pause. And extra club chocolate bar feeds.

4-Count Popcorn Feed

Juggler/beat	1	2
A	C	B
B	A	T-self
C	T-self	A

- Right hand counting
- B starts with 4

6-Count Popcorn Feed

Juggler/beat	1	2	3
A	C	T-self	B
B	A		T-self
C	T-self	A	

- Right hand counting
- B starts with 4

This variation makes a nice triangle too.

Note: you can replace any triple self, self, single pass with a triple pass, single self to make things more interesting, or with double straight self, double straight self, pass (533p, 5p33, 443p, 44px3 all work).

5-Count Popcorn Feed (one variation)

Juggler/beat	1	2	3	4	5
A	D-B		D-C		
B		T-self		D-A	
C		D-A			T-self

- Both hands counting, start with right hands
- A and C start with 4 clubs

The timing is a bit wonky, B and C should delay slightly at the start.

4.5p:B 3 4.5p:C 3 3 | 3 5 3 4.5p:A 3 | 3 4.5p:A 3 5 3

Extra Clubs Chocolate Bar Feed (one variation)

Juggler/beat	1	2	3	4
A	Dx-B	Dx-B	Dx-C	Dx-C
B	A	A	D-self	D-self
C	D-self	D-self	A	A

- Both hands counting, start with right hands
- A and C start with 4 clubs
- A throws all crossing doubles
- B and C throw chocolate bar, then double self, double self
- The double selves are straight

Fast/Slow Feeds, Gorilla Feeds, Site-Swap Feeds... we do all of them in Madison, but they're not part of the Pattern Book yet!

Triangles

Math geeks recognize that the positions of any three non-colinear jugglers form vertices of a triangle. But that's not what jugglers mean by triangle – they mean equilateral triangle. When 3 jugglers are so evenly positioned, three obvious passing formations are suggested: the inside triangle (pass to the juggler on the left with a right hand pass), outside triangle (pass to the juggler on the right with a right hand pass), and two jugglers pass with each other while the other does a self. These simple building blocks can be combined in a delightful variety of ways to provide hours of instruction and diversion. (You may already be familiar with the Hovey's Nightmare variations.) Mastery of such triangles is very useful for larger and more complex patterns.

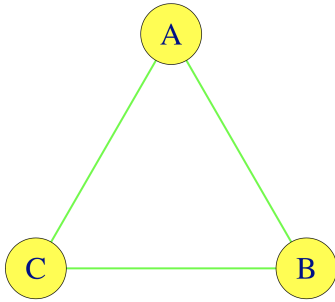

Rotating Feed

The Rotating Feed Triangle is the simplest rotating feed. For 3 jugglers, a rotating feed is the same as a feast.

Juggler/beat	1	2	3
A	B		C
B		A	C
C			B A

- Right hand counting

Pulsar

Juggler/beat	1	2	3	4	5	6	7	8	9	10	11	12
A	B	C		C		B	C	B	C		B	
B		A		C		C	A		A		C	A
C			A	B	A	B		A		A	B	

- Right hand counting
- Rules:
 - Jugglers take turns as feeders: A is first, then C, then B (repeat).
 - Each feeder feeds the other 2 jugglers.
 - The next feeder feeds in the opposite order of the previous feeder.

A starts as the feeder and feeds right-left. C is the next feeder and feeds opposite of A, so C feeds left-right. B, the next feeder, feeds opposite of C, namely, right-left. A then feeds left-right, followed by C with right-left, and B finishes the pattern with left-right.

I recommend that feeders call out what they are doing (right-left or left-right) so that the next feeder will know what to do. This will also help every juggler know what is going on.

With the rules and the recommendation, you won't have to memorize all of the passes in the stinking table.

Try this with 1-count, so that both hands pass when you are the feeder.

Pulsar dates to 1993 by Steve Otteson and MAJ.

Puzzle and Variations

Three-piece Puzzle (for 2 jugglers)

Right, self, right, self, self, left, self, self, self, left, self, self.

Puzzle Feeder (for 3 jugglers)

Juggler/beat	1	2	3	4	5	6	7	8	9	10	11	12
A	C		C	B		C	B		B	C		B
B				A			A		A			A
C	A		A			A				A		

- Both hands counting, right hand starts

A is the feeder, and B and C are doing the Three-piece Puzzle pattern six throws out of phase.

Puzzle Feast

Juggler/beat	1	2	3	4	5	6	7	8	9	10	11	12
A	C	B		C	B		B	C		B	C	
B	A	C		A	C		C	A		C	A	
C	B	A		B	A		A	B		A	B	

- Both hands counting, right hand starts

In the Puzzle Feast, all 3 jugglers are doing what A did in the Puzzle Feeder pattern.

Three-piece Puzzle and Puzzle Feeder patterns are by Jim Brennen. Puzzle Feast is by Steve Otteson.

Siteswap Feeds

Here are two nice variations related to a Martin's Madness feed.

Juggler/beat	1	2	3
A		D-B	D-C 1
B		A	
C			A

- Both hands counting, right hand starts

A does 441 (i.e. double pass, double pass, shuffle)

Alternatively, A can throw cross double passes and B and C can throw cross passes too (starting on opposite hands).

Juggler/beat	1	2	3
A	T-C	B	1
B		A	
C			A

- Both hands counting, right hand starts
- A does 5px3px1 (i.e. triple pass, single pass, shuffle)

Alternatively, A can throw straight passes and B and C can throw cross passes (starting on opposite hands).

Q: Luke, is this correct?

Extra Club Rotating Feed (for 3 jugglers)

There are several versions of the extra club rotating feed, but this is one of my favorites based on an extra club 2 count feed (10 club 2-count). After each feed sweep, the feeder must throw a right to left self double to adjust the timing of the pattern. Also, the old feeder throws 2 passes in a row to the new feeder to transfer the extra club.

Juggler/beat	1	2	3	4	5	6	7	8	9
A	D-B		D-C		D-C		D-self	Pause	
B		D-A		D-self	Pause		D-C		D-C
C	D-self	Pause		D-A		D-B		D-B	

- Both hands counting.
- A and C start with right hand.
- B starts with left hand

Variations:

Once you're comfortable with this pattern, try pirouetting under the double self, or instead of throwing the double self, do two single selves and an early triple straight pass instead (followed by a pause), or both! By Luke Emery 1999.

Extra Club Triangles

There are a lot of nice extra-club triangle variations. Here are a few examples to play with.

10 Club 3 Count Triangle

This pattern is based on the standard 7 club 3-count in double spins and extends it to a triangle. All passes cross (rights to right, lefts to left). This version has 10 clubs, and A starts with 4 clubs.

Juggler/beat	1	2	3
A	D-C		
B		D-B	
C			D-A

- Both hands counting
- All jugglers start in sync with right hand
- All passes cross

If that isn't challenging enough. Add more clubs and passes. A and C start with 4.

11 Club 2 of 3 Count Triangle

Juggler/beat	1	2	3
A	D-C	D-C	
B		D-B	D-B
C	D-A		D-A

12 Club 1-Count Triangle

Juggler/beat	1	2	3
A	D-C	D-C	D-C
B	D-B	D-B	D-B
C	D-A	D-A	D-A

The 10 club version has been around for some time. We learned it from some fellow club passers at a convention, but I don't remember from whom. 11 Club and 12 Club variations by Luke Emery, 2005, although it seems likely that other jugglers have also tried them.

There are corresponding extensions to a 5 person star in the 5 Person Patterns.

10 Club Triangle with Triple-Single-Single

Here's another variation on a 10 club triangle from 4-count 7 with triples.

Juggler/beat	1	2	3
A	T-C	B	C
B	C	A	T-A
C	B	T-B	A

- Right hand counting

You can skip all the single passes until the triple passes are reliable.

6-Count Popcorn Triangle

Juggler/beat	1	2	3
A	C		T-self
B		T-self	A
C	T-self	B	

- Right hand counting
- A starts with 4

5-Count Popcorn Triangle

Juggler/beat	1	2	3	4	5
A	C			T-self	
B			T-self		A
C	T-self		B		

- Both hand counting
- A starts with 4 and right hand
- C starts with left
- B starts with right
- All passes are crossing and alternate hands

Timing is wonky (hands aren't all synced up, so the table is a little misleading... C should wait a bit before the first triple, throw high lofty single crossing passes): 3.3px 3 3 5 3.

The pattern should be possible in 5-count with triple crossing passes too... Hmm... But fast...

Another 5-Count triangle is to throw crossing triples to the left in 5-count. This timing is also wonky 1 2/3 count or some such difference between each juggler.

10 Club 4-Count Triangle

The juggler with 4 clubs starts with a right hand double to the left and then repeats in 4-count. Each juggler passes a right handed double to the left as the incoming double pass approaches. The timing on this pattern is not symmetric. Each juggler is 1/3 beat out of time with the juggler before. This pattern can be extended to a number of interesting variations, such as the Bubbler of David.

Lines

The Line is another classic family of patterns with countless variations. Here are a few we often juggle in Madison.

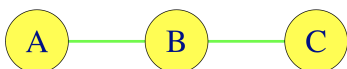

Mel in the Middle

A double 3 count pass with a moving juggler in the middle spinning around. If Mel is B (Mel is always B), and starts facing A, then it looks like this.

Juggler/beat	1	2	3	4	5	6	7	8	9	10	11	12
A	C	B		C			C	B		C		
B		A			C			A			C	
C	A			A	B		A			A	B	

- Both hands counting

Peter's Backcrosses

If you replace Mel with Peter, change to 3-count, remove spinning and add backcrosses, you get this pattern.

All jugglers are in 3-count. Use the exact same pass sequence, but B (that's Peter – ok, Mel isn't *always* B) faces perpendicular to the line from A to B and makes all the passes as backcrosses, alternately to A and C.

Swiftly Tilting Popcorn

Extra club version of Mel in the Middle, except in 4-count instead of 3-count. Inside person whirls with half pirouettes under doubles while outsides do popcorn. All passes are right handed.

Juggler/beat	1	2	3	4	5	6	7	8	9	10	11	12	13	14
A	D-C		B		D-C		T-self		D-C		D-C		B	
B			A		D-self	½ P		C		D-self	½ P		A	
C		T-self		D-A		D-A		B		D-A		D-A		T-self

- Both hands counting
- A starts with 4 clubs, right hand
- B starts facing A, right hand
- C starts with left hand
- ½ P marks half pirouette underneath the double
- 1 is the same as 11. This is just one possible variation of spinning underneath popcorn.

Dropback Line

A passes to B. B drops back to C. C passes to A. You can do a dropback line in any count: 2-count, 4-count, 3-count, chocolate bar. It's a nice pattern to add clubs to as well. Try one two, or 3 extra clubs with doubles or one extra club in 3-count (A and B cross, C throws straight).

Line Feed

You can do any of the feed variations in a line layout instead of a V. Some will be useful for more complex patterns. Also see 4 person Lines.

Extra Club Line

What do you do if there are 3 club passers and one is more advanced, one is intermediate and the third is a beginner. Here's a nice pattern to accommodate everyone!

A and B face each other. C faces A and B.

Juggler/beat	1	2	3	4
A	D-C		B	
B			A	
C	T		D-A	

- Both hands counting
- A starts with 4 clubs.

A alternates right hand doubles to C and singles to B. B does right hand 4-count to A. A alternates right triple selves and doubles to A (fast popcorn).

Turbos

Bruno's nightmare

We haven't juggled this much in Madison, but we mention it for reference. It used to be popular in Europe! See PassingDB¹

Turbo (standard)

A Turbo is a group of 3 weaving jugglers who feed themselves. It is also a Two-leaf Clover or a continuous change sides feed through the middle. Pass every right hand throw when you are feeding, and pass every other when you are not feeding.

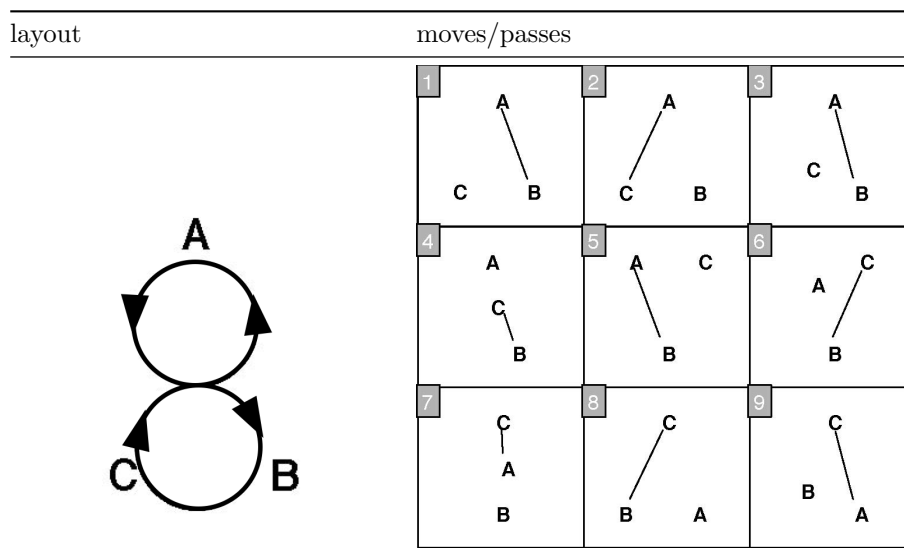

It's 18 right-hand beats for a full cycle; 9 beats to repeat the passing sequence, but flipped in orientation. When a juggler moves to the other side, he or she cuts across in front of the old feeder, and turns around to pass to the new feeder.

¹<https://www.passingdb.com/patterns.php?id=49>

Juggler/beat	1	2	3	4	5	6	7	8	9
A	B	C	B		B		C		C
B	A		A	C	A	C		C	
C		A		B		B	A	B	A

- Right-hand counting
- A cool animation (thanks Nick!)²

History: We're not sure. Turbo may have developed inadvertently when in the early 90's we tried, unsuccessfully, to recreate Bruno's Nightmare from faulty memory. The main difference between Bruno's Nightmare and Turbo is when you turn. In Turbo you turn before entering the middle. In Bruno's Nightmare you turn after exiting the middle, which lengthens the cycle and makes the pattern easier by some measures. There is also variations of Bruno's Nightmare that we've heard about but we don't juggle.

To learn the Turbo, start by practicing a regular feed change sides. Then learn the feed change sides through the middle. Finally, speed up the change side moves until the feedees all move at the earliest possible opportunity.

Jazzing it up: When changing sides the mover has the option of clockwise or counter-clockwise turns. Try both. One is harder and cooler. The standard (inside) turn is usually easier for right-handers off the right side of the feed and harder for right-handers off the left side. Try double or triple earlies before entering the middle. Try a behind-the-back pass when moving off the right side.

Count and Hand Variations

There are a lot of Turbo variations. Turbos can be done in almost any count and combined in many different ways.

- **Left Handed** – Same as above, but mirror image.
- **3-count** – Feeder does 3 count, feedees do 6 count.
- **Chocolate Bar** – Fun!
- **Double 3 count** – Tricky. There are 2 different ways to do the transitions. Usually we have the movers stay in 3-count and move on the inside hand throw. You can also do this pattern where the movers transition in 4 count and move on the outside hand throw. Feels a little like the El Nino.
- **Tom's Turbo** – Feeder is in 1-count and does 3 passes in a row to each feeder. Have each juggler start with a different set of clubs. (Created by Tom Pomraning.)
- **10-Club Turbo** – See below.
- Also see Interlocking Turbos in 6 person patterns and Strange Attractor in 5 person patterns.

10-Club Turbo

The 10 Club Turbo has the same positions and movement as the Turbo but with an extra club. Usually we throw the passes as doubles (same as in 7 club 2-count). In order to keep the timing the mover must add an extra beat into the pattern. That can be done by throwing a double self (either right or left) to the opposite hand or by throwing an early triple pass and pausing for one beat. The diagram below shows the early triple, but experiment with whatever works best for you (some people think a right to left double is easier).

Juggler/beat	1	2	3	4	5	6	7	8	9	10	11	12	13	14
A	D-B		D-C		D-C				D-C	Move			T-B	Pause
B		D-A	Move			T-C	Pause				D-C		D-A	
C				D-A		D-B		D-A		D-B		D-B		

²<http://juggloid.com/editor/?s=npRW7l>

- Both hands counting
- A starts with right hand.
- B and C start with left hand.

The table shows 2 transitions. Note that the old feeder (A) passes twice in a row to the new feeder (C). The mover (B) throws a triple to the new feeder at the SAME time as the new feeder throws a double to the mover and then pauses for one beat. The feeder and the 2 feedees are always on opposite timings (the feeder's right is synchronized with the feedees' lefts).

The easiest way to learn is by practicing the change sides feed with transitions on the outside and getting comfortable with the triple or the self double timing transition. Then learn the inside transition and finally rev it up to true turbo speed. Excelsior!

By Luke Emery, 1999.

Even more variations:

Try with single passes instead of double passes in 7 club 2 count singles speed.

We worked out an 11-Club Turbo variation with triple selves on the transitions, but it's too hard for us to run more than a couple transitions at a time. Maybe we'll get it in a future version of the book.

Another 10-Club Turbo

The pattern above will always be **the** 10-Club Turbo, but here is another version that makes a nice diversion. It's based on an extra club feed too, but the transitions in the middle are made by a half pirouette underneath a right to left double.

The feedee who is moving first steps into the middle of the pattern directly between the feeder and the non-moving feedee. After one pass the moving feedee does a half pirouette underneath a double right to left self throw, Then steps back to complete a single turbo transition. The table below has one complete transition.

Juggler/beat	1	2	3	4	5	6	7	8	9	10	11
A	D-B		D-C		D-B		D-C		D-C		
B		D-A				D-A		D-self			D-C
C				D-A				D-A		D-B	

- Both hands counting
- A starts with R
- B and C start with L
- D-self is a half pirouette

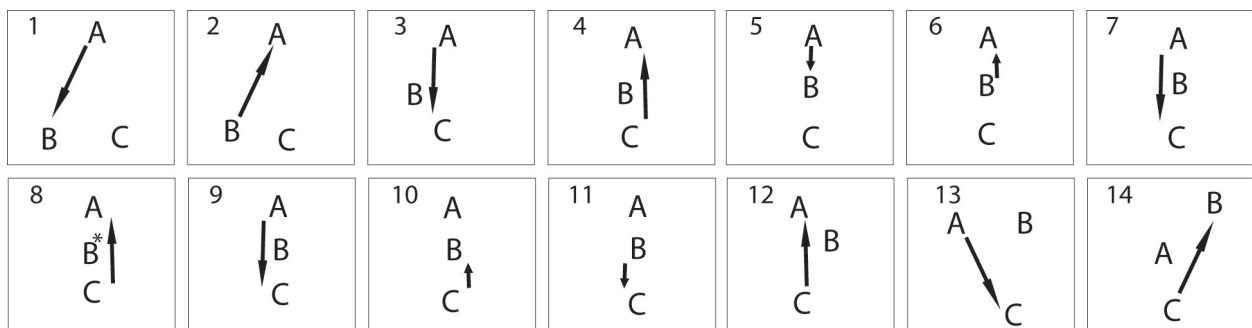

B self double
1/2 pirouette

Starts Over
A is new mover

When you do the half pirouette, make sure to throw the double more inside than usual and have the outside passers pass a little on the wide side to reduce collisions.

By Luke Emery, 2002.

GDP

Luke's GDP is a sort of extra-club continuous change-sides feed. We like to practice it after doing the extra-club turbo; it's a fine pairing!

Juggler/beat	1	2	3	4	5	6	7	8	9
A	T-C	B	T-C	Move	C	Move		T-B	
B		A	Move		T-C		T-A	C	T-A
C		T-A		T-B	A	T-B	Move	B	Move

- Right hand counting

A starts with 4 clubs and passes triple to C, single to A. B faces A, starts with a self, and passes every others to A. C starts with a self, then triple every others to A.

The description above is the base pattern without movement. We will follow the pattern of movement by concentrating on B. All jugglers do the following sequence at different times.

Right hand counting:

B: self, single to A, self, self (while replacing A), triple to C, self (A replaces C), triple to A, single to C, triple to A, self, (as B moves to the middle). Start over. Be careful to keep your triples from hitting the non-recipient!

By Luke Emery, 1999.

Variations:

Doubles – Throw doubles instead of singles.

A variety of tricks can be done while moving into the center (such as an early triple followed by a pirouette).

See also a variation we call Cathedral in the 5 Person Patterns.

Laura's Weave

Peter came up with this pattern as a birthday present for Laura in 2010.

Three jugglers move in a figure eight, as in a standard weave but with no feeder. There's one extra club. On right-hand counting, it's triple self, triple pass, then four single selves as you move over to the other side. This same sequence can be done with straight-up passes in the middle of the weave.

$2\pi/3$

Read this *two pi on three*. This one is a late bloomer, considering how simple it is and how long people have been juggling and moving in groups of three. There are three moving jugglers, A, B, and C, and six passing beats for a full cycle: (on count of choice; rows of tables). Everyone moves through the figure eight; in contrast to a Turbo or Bruno's nightmare, there is not a feeder being swapped here; all folks are moving

all the time. Four count is fun; three count is more fun. In any count, it's pass-one, pass-the other, self. Whatever is the base count the pattern has a gap (in this layout, positions 2 and 5) where you can plug in any other juggler or pattern that matches that count (including three other jugglers doing a $2\pi/3!$). Looks like two pies when viewed from above, and it's 3 jugglers. Plus, each circle in the layout is divided into 3, hence the name. Mike invented $2\pi/3$ in summer 2017 and we juggled it a lot then.

positions				passes			
	A	B	C		A	B	C
1	1	5	3	1	C		A
2	2	6	4	2		C	B
3	3	1	5	3	B	A	
4	4	2	6	4	C		A
5	5	3	1	5		C	B
6	6	4	2	6	B	A	

Layout

Passes

Up-Up-Over

Here's a curious pattern that exercises your 4-club columns skill. Jugglers A and B start with 4 clubs each. Juggler C starts with 2 clubs. The vertical arrow in the table means *up*, i.e., throw two clubs up as double selves. Feeder A is doing a slow two-hand doubles feed, starting with C. Juggler B starts in sync with A and does *up-up-over*. Juggler C waits to receive the two incoming from A and then responds with *up-up-over*.

A	1	2	3	4	5	6
B C	A C			B		
B C	↑		A		↑	
C		↑		↑		A

positions

simultaneous double throws
A and B start with 4 clubs
C starts with 2 clubs
vertical arrow is synced double self

Mike and Steve did this first in the early 90's, when Madfest was still in the Memorial Union. See an animation of (a variation of!!) this pattern at Juggloid³

Graham's 3 stuff

Here are some patterns for 3 jugglers by Graham Paasch.

Change Sides Double-3 Count Feed Plus

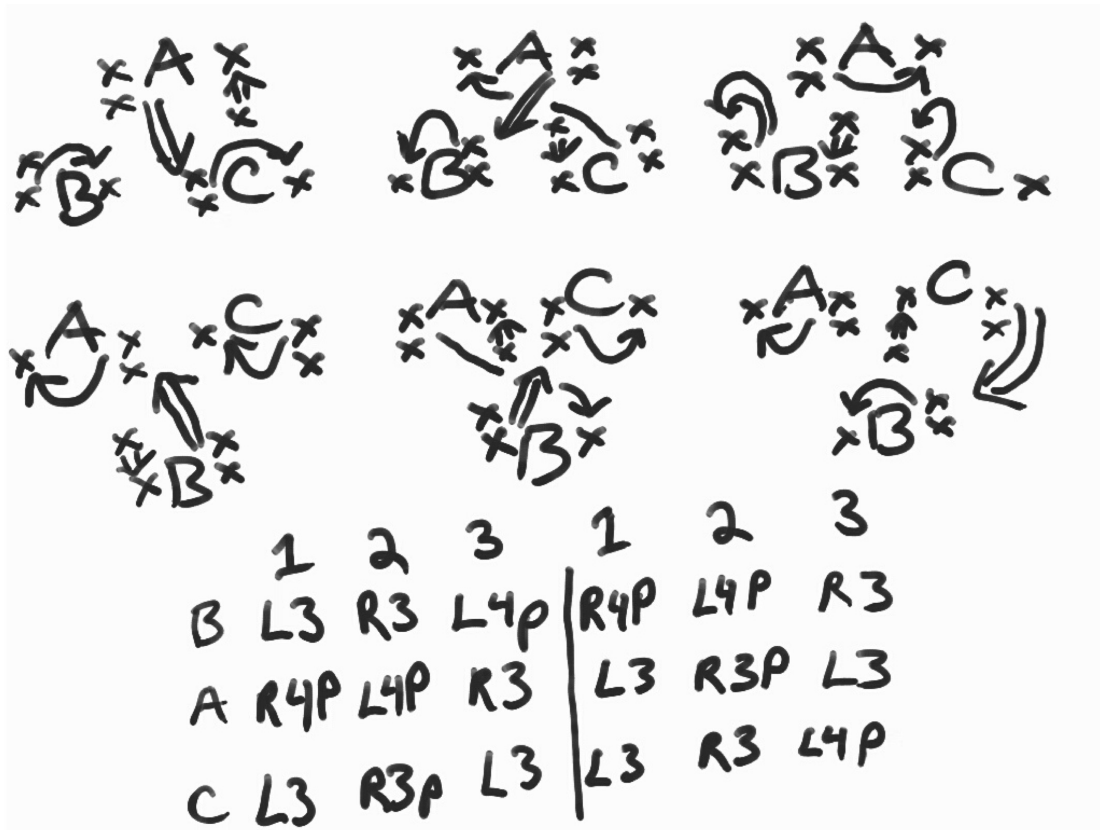

³<http://juggloid.com/editor/?s=yhIKp1>

Change Sides RRLRLRLRLRL

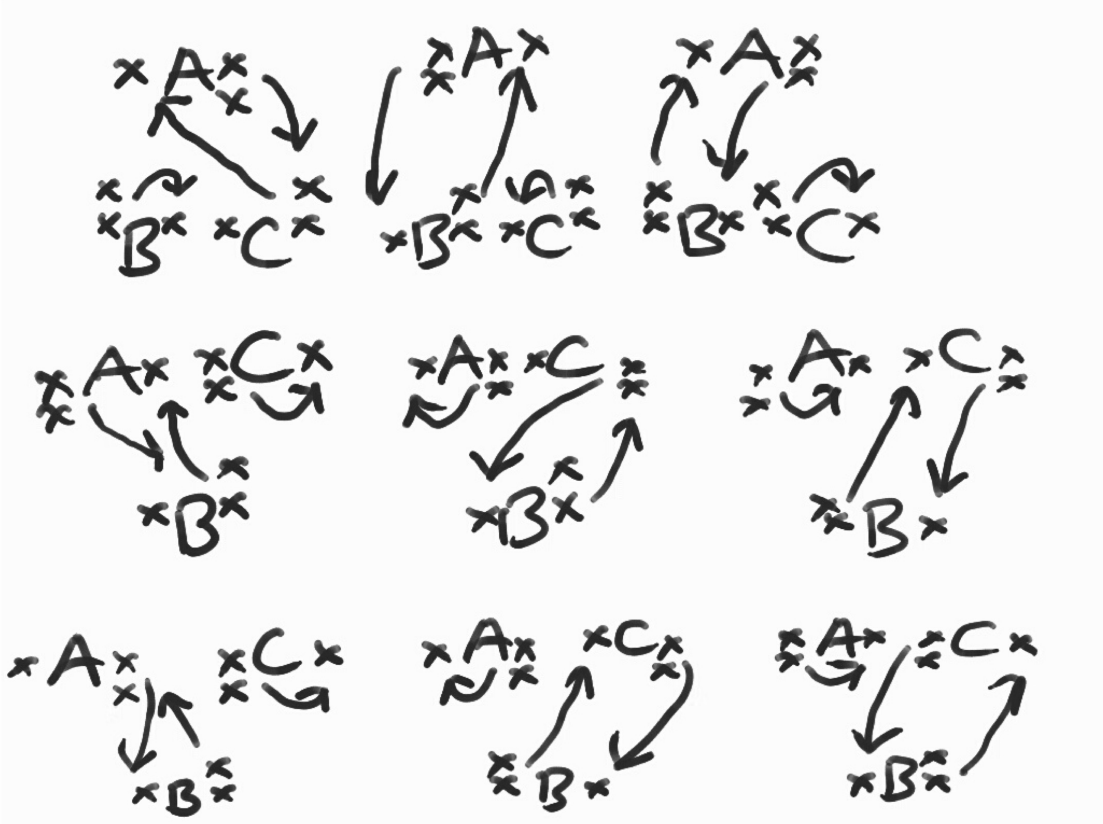

Safe Beast of Arg

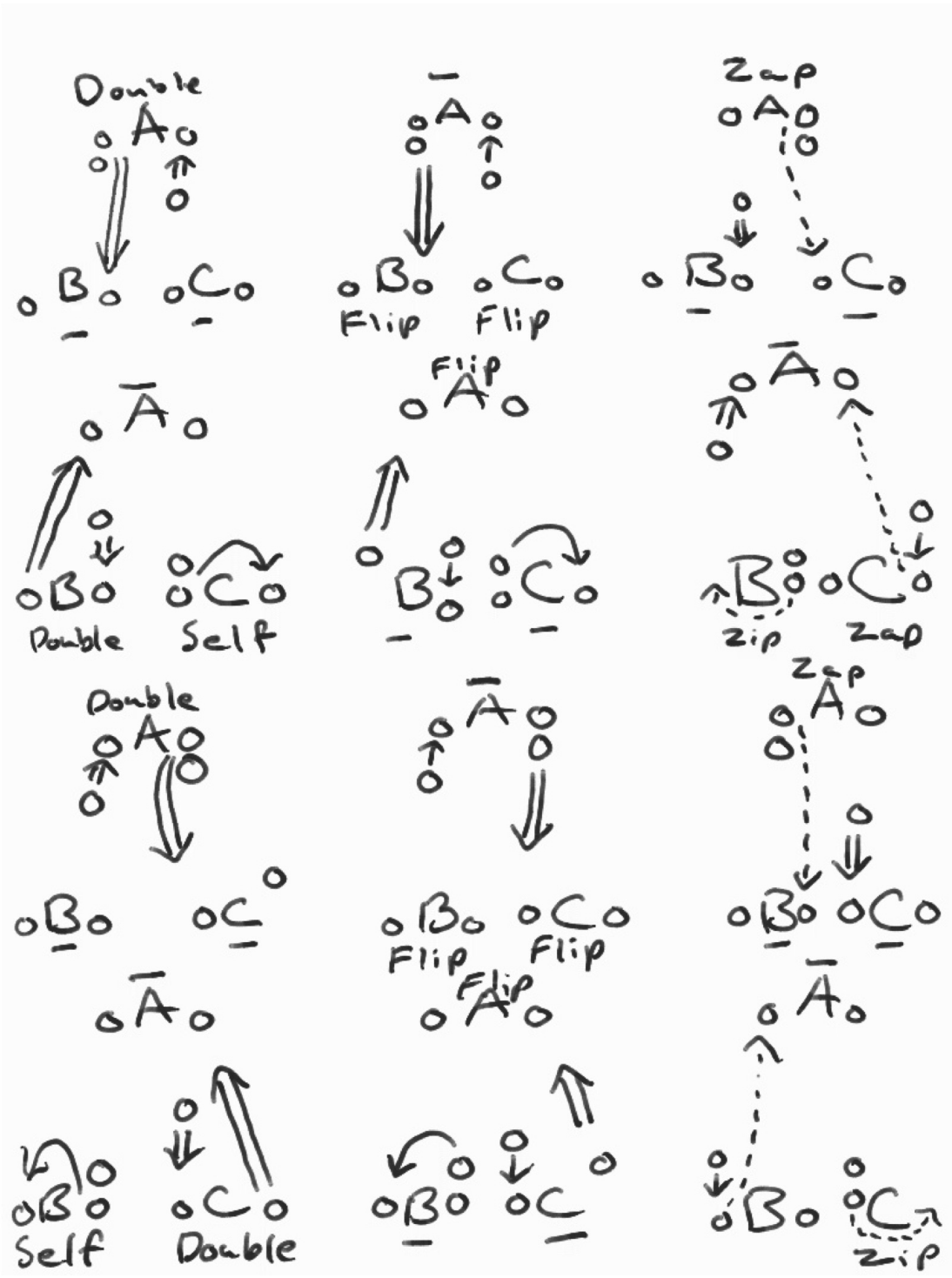

Chapter 4

4-Person Patterns

Boxes

The box is a classic passing pattern with dozens of variations, many of which have been around for a long time. It's a great foundation for innovating new patterns.

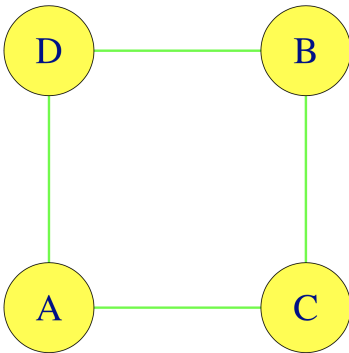

Basic 4-Count Box

Juggler/beat	1	2
A		B
B		A
C		D
D		C

- Right hand counting

2-Count Box

Juggler/beat	1	2	3	4
A		B	B	
B		A	A	

Juggler/beat	1	2	3	4
C			D	D
D			C	C

- Both hands counting
- A, B start with right
- C, D start with left

1-Count Asynchronous Box

Juggler/beat	1	2
A	B	B
B	A	A
C	D	D
D	C	C

- Both hands counting

This is a good exercise to practice timing. All jugglers throw at exactly the same time. Wide throws make it a little easier. You can do the same pattern with synchronous ultimates, but that's pretty hard.

Almost any staggered passing pattern will work with a box, and many that are synchronous. A moving variation in 4 count is for C and D to swap places when A and B pass and vice versa. Other variations are Pistons and the Minuet.

Extra Club Boxes

- **13 Club Box** – Throw a double right pass to the juggler on your left in 4-count. Each passer passes on their own beat.
- **14 Club Box** – This can be done with pairs of jugglers synchronized in a 7 club 2-count, but it is easiest if each juggler is $\frac{1}{2}$ beat after each other.
- **14 Club 4-Count Box** – This is a box where each pair of juggler does 7 club 4-count with triples. The two pairs are 1 beat away from each other (A and B's rights are synchronized with C and D's lefts).
- **16 Club Box** – There are several nice 16 club box variations. To reduce collisions, have A and C throw triples while B and D throw singles ($\frac{1}{2}$ beat after each other). The overall timing is about the same as 8 doubles (or 7 singles). This is a pretty pattern. You can also do a 16 club box pattern with all the jugglers synchronized in 8 club 2-count singles, doubles or triples. Nice! Pass either straight across, or to the juggler on the left.
- **18 Club Box** – With 9 club triples 2 count and each juggler offset $\frac{1}{2}$ beat. However, if you are doing this pattern, you probably don't need our suggestions on club passing in a box... Very cool, but tricky!
- Also see Fireworks.

14-Club Ultimate Box

If the timing is perfect, it is possible to do a 14 club box in 1-count, with right hand doubles across the box and left hand singles along the edges of the box.

Juggler/beat	1	2
A	D-B	C
B	D	D-A
C	D-D	B
D	A	D-C

- Both hands counting
- A and C start with 4 clubs and right hands
- B and D start with 3 clubs and left hands

Throw a little wide on the double passes and make sure that everyone has metronome perfect timing and it actually works!

Pattern by Luke Emery, 2007. **Q. Luke. C is not on A's left; should C-D swap?**

Bermuda Quadrangle

Juggler/beat	1	2	3	4
A	B	C	D	
B	C		A	D
C	A	D		B
D		A	B	C

- Both hands counting
- Start with right-hand

Bermuda Quadrangle by Laura and Becky Provance, Barry Friedman, and Steve Otteson.

Maya

Juggler/beat	1	2	3	4	5	6
A	D		B	C		B
B	C		A	D		A
C	B	D		A	D	
D	A	C		B	C	

- Both hands counting
- Start with right-hand

Maya, by Tom Pomraning, was published in Jugglers World. Tom makes incredible chocolates as well as juggling patterns.

Interlocking Triangles

Juggler/beat	1	2
A	B	B
B	D	C
C		A
D	A	

- Right hand counting

Spider Web

This is a variation of the box with 3 extra clubs and all right hand passes.

Juggler/beat	1	2	3	4
A	T-C		D-B	
B		T-D		D-C
C	D-D		T-A	
D		D-A		T-B

- Both hands counting, all passes with right hand
- A and C start with right
- B and D start with left
- A, B and C start with 4 clubs

Extra Club Rotating Feed (for 4 jugglers)

This is a box pattern with a rotating feed for 4 jugglers and one extra club; both directions work.

Juggler/beat	1	2	3	4	5	6	7	8	9	10	11	12
A	D-C		D-B		D-self	Pause		D-C		D-self	Pause	
B	D-self	Pause		D-D		D-C		D-self	Pause		D-D	
C		D-A		D-self	Pause		D-A		D-D		D-self	Pause
D		D-self	Pause		D-B		D-self	Pause		D-B		D-A

- Both hands counting, all right hand throws are either double passes or double selves
- A starts with 4 clubs
- A and B start with right hand
- C and D start with left hand

The steady state right hand sequence is pass across, pass left, self, pass across, self.

Pattern by Luke Emery, 1999.

Gustav

This is a double 3-count extra club pattern for four jugglers in a box pattern.

Juggler/beat	1	2	3	4	5	6
A	T-D		C	T-D		C

Juggler/beat	1	2	3	4	5	6
B	D			D		
C			A			A
D	B	T-A		B	T-A	

- Both hands counting
- A starts with 4 clubs
- A throws triple crosses, B throws triple straights
- C and D start slightly after A and B – timing is a bit wonky

Pattern by Luke Emery, 2008 and named after the hurricane.

Switch Sides Feed

The standard Switch Sides Feed is an easy introduction to moving while passing. The extra club version is a fun and spectacular pattern. The basic idea is that a feeder feeds three feedees, but the feedees on the end move straight across after every pass so that the middle feedee becomes the new feeder after each sweep.

Windshield Wiper Switch Sides Feed

Juggler/beat	1	2	3	4	5	6	7	8
A	B	C	D	C		C		C
B	A				C			
C		A		A	B	A	D	A
D			A				C	

- Right hands counting
- Start with right hand

In this version, movers go back and forth, passing 8-count.

Typewriter Switch Sides Feed

Juggler/beat	1	2	3	4	5	6
A	B	C	D		C	
B	A			C		
C		A		B	A	D
D			A			C

- Right hands counting
- Start with right hand

Extra Club Switch Sides Feed

In this version, weavers move back and forth in an 6-count. This is a fun one.

Juggler/beat	1	2	3	4	5	6	7	8	9	10	11	12	13	14
A	D-B		D-C		D-D		D-C				D-C			
B		D-A		D-self	½ P				D-C		D-self	½ P		
C				D-A				D-B		D-A		D-D		D-A
D	D-self	½ P				D-A		D-self	½ P				D-C	

- Both hands counting, all passes are right handed
- A starts with right hand and 4 clubs
- B, C and D start with left hand
- ½ P marks a half pirouette underneath the Right to Left double self throw

Pattern by Luke Emery.

Weaves

Standard Weave

Here's where the fun really begins! This is a great pattern to master because it leads to many other exciting patterns.

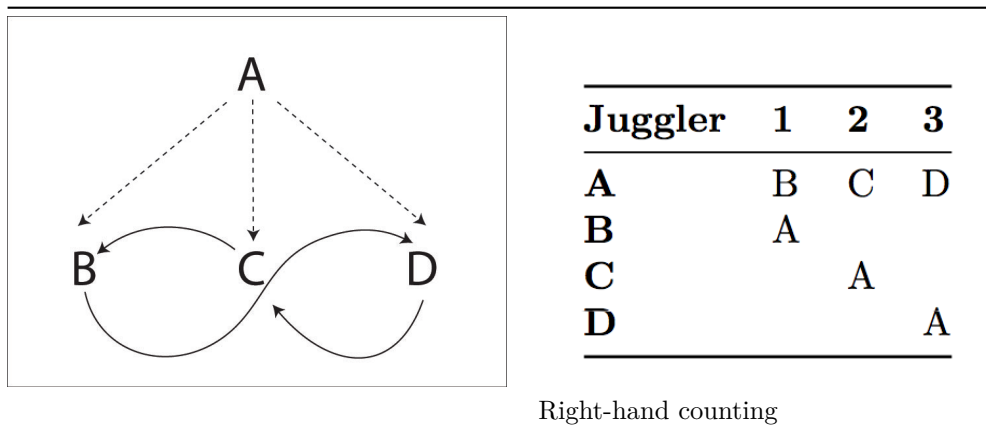

The feeder, A, throws to the end, middle, end, middle and then repeats, passing in 2-count. That's called a wind-shield wiper feed (as opposed to a typewriter feed that only goes in one direction). Each weaver, (B,C,D), passes in their current position and then moves to the next position. For the standard weave, the three movers pass in a 6-count, moving back on the ends and forward in the middle in a figure eight pattern. Beginners have a tendency to move well side-to-side but not so well backwards and forwards; think of the pattern more like a bowtie than a figure 8 if that's a problem. Notice also that it's a 12-beat cycle for everyone to get back to the same positions, but the passing cycle takes on 3 beats, as the table above shows.

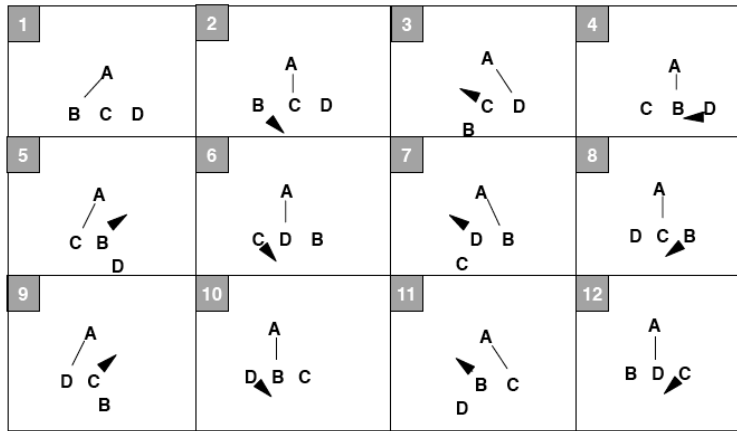

Note on starting: The middle weaver moves towards the end that passes to the feeder first.

Here's another look at the details of the standard weave; the feeder exchanges with jugglers in positions 1, 4, 7, and 10 (which is 4, going the other way). Weavers move regularly through the 12 positions. This detail is helpful when we start thinking about Fois-Graham and other complicated double weaves.

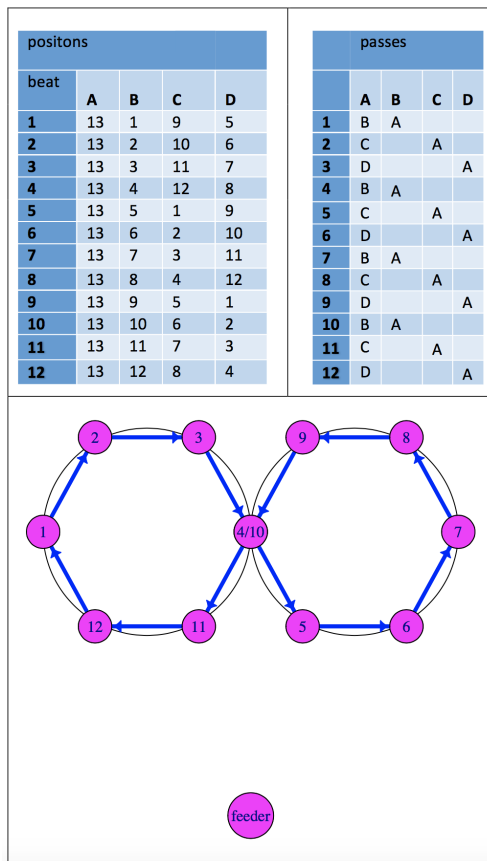

Variations:

Oh, there are so many variations of the weave! The mind boggles. To start, try with left handed throws in 2-count feeding. Try moving forward on the ends and back in the middle (an inverted weave). Now try with chocolate bar (feeder throws ultimates, Right, and then Left to each feeder.)

You can do this pattern with an extra club, all passes as doubles, or all throws as singles, or feeder throwing singles and weavers throwing triples, or feeder throwing all triples and weavers throwing singles.

Do this pattern with 2 extra clubs and all the passes are triples.

Slow it down and pass twice in a row from the feeder to each weaver.

In general, the weavers can move in many different counts, and the feeder can choose a pattern that makes the weave work as long as two weavers aren't passing at the same time. You can slow the weave down if you want, or speed it up. Here are some examples (all of these in both hands counting):

5-Count Weave: Feeder PSPSP=5/3-Count, Feedees 5-Count

Juggler/beat	1	2	3	4	5	6	7	8	9	10
A	B	C	D	B	C	D				
B	A				A					
C			A				A			
D				A						A

There are other variations that also work out as a 5-count Weave (like the feeder throwing PPPSS instead of PSPSP).

Double 3-Count Weave: Feeder 3/2-Count, Feedees 4-then-5-Count

Juggler/beat	1	2	3	4	5	6	7	8	9
A	B	C	D	B	C	D			
B	A				A				
C			A				A		
D				A					A

In this variation, the weavers move in a 5 count to the middle and a 4 count to the outsides. We also call this the 4-count-5-count weave. Notice the 3/2 feeder starts pass-self-pass-pass. The inverse works too, but is a bit harder.

The variations with a 4-count or 3 of 4-count for the feeders don't work with the standard feed, but see the Iron Cross Weave, Spiral Weave or Twister Weave for more 4-count weave variations.

Hyper-Weave: Feeder 1-Count, Feedees 3-Count

Juggler/beat	1	2	3	4	5	6
A	B	C	D	B	C	D
B	A			A		
C			A		A	
D				A		A

Ok, this is about as fast as a weave can get. It's really fast and really hard. Throw really high lofty slow passes, move fast and hope for the best. If you can do this weave, make sure you stop by Madison some time and do some fun juggling with us!

Also see Mr. Inside Mr. Outside Weaves, Inside Out Weaves, Twister Weaves, etc.

There are a number of variations floating around where the weavers trade place with the feeder (typically on one end only). Work it out.

Dresser-Drawer Weave

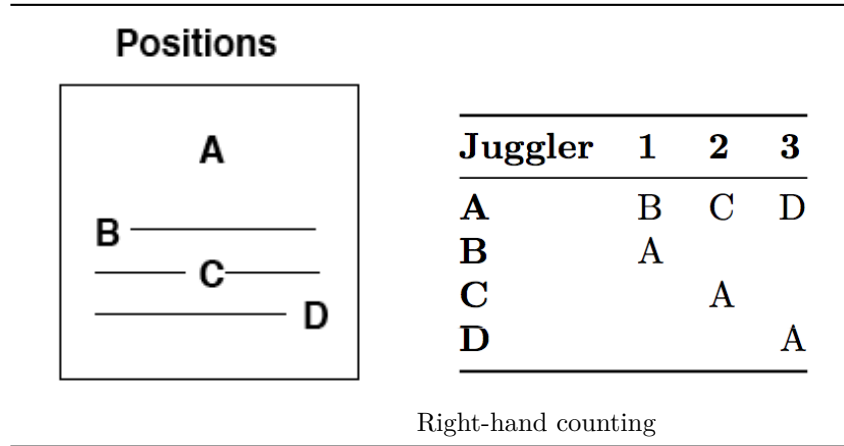

This weave variation has the same passes as the standard weave, but the weavers move side-to-side like dresser drawers instead of through a figure eight. Usually we debate whether B is the socks or underwear drawer. Each juggler has its own slot (i.e. *drawer*) to move on. Each slot has three positions: left, middle, and right. Weavers move back and forth on their slots. Moves are made to the next position after the pass is made from the current position.

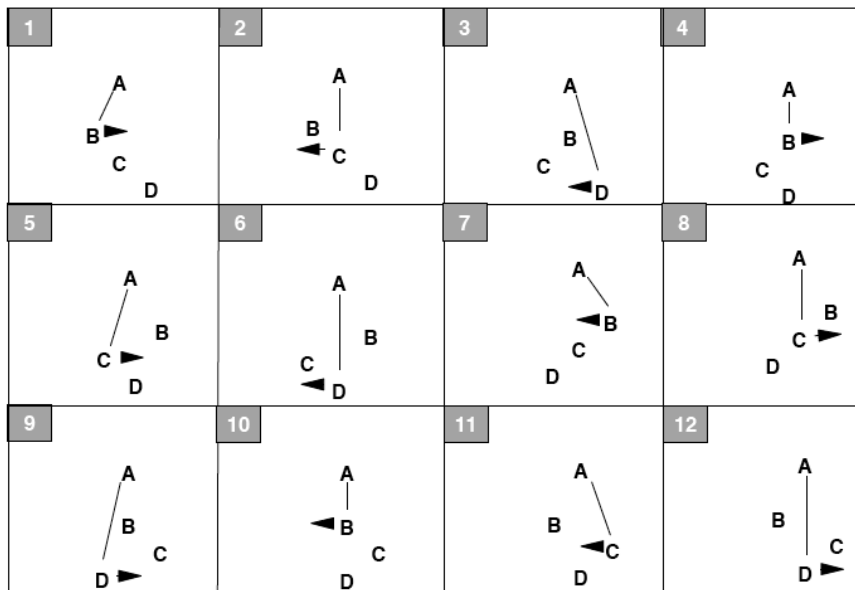

The weave predates the MAJ. Seems like the Flying Karamozov's must have done it. We've been weaving since 1992.

Inside-Out Weave

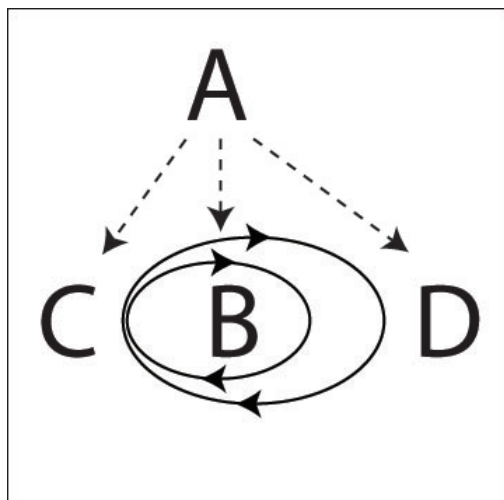

Take the path of a standard weave – a figure eight – and imagine warping space so that one of the loops shrinks a bit and is folded back inside the other. That’s the Inside-Out Weave.

The count and the passes are exactly the same as the standard weave, but the jugglers move in a small loop from the new center (which is in the middle, but has the count and movement for an end) to the “middle” (which is now on the outside), and then in a large loop back (the other end) . In the loops always move forwards for the “middle” (where C starts) and backwards from the “ends” (where B and D are).

The passing lanes can be somewhat narrow, so be careful, or you might bruise your ZOC.

Pattern by Mike Newton.

It’s a Good One

For a count challenge with no extra clubs, but in the standard weave formation, the Feeder (A) passes 2 count, twice in a row to each feedee on each side. Feedees (B,C, D) throw: 2 throws of 2-count, 3-count transition, left-handed 4-count, 3-count transition, and repeat on other side. Set up with A facing B, C, D, with C in the middle, moving forward and to the left.

4 jugglers/ both hands counting	1	2	3	4	5	6	7	8	9	10	11	12
A	C	-	C	-	B	-	B	-	D	-	D	-
B	-	D	-	-	A	-	A	-	-	C	-	-
C	A	-	A	-	-	D	-	-	-	B	-	-
D	-	B	-	-	-	C	-	-	A	-	A	-

Gandini Weave

The Gandini Juggling Project has explored a lot of interesting weaves (see Chapter 12 for more examples). We call any weave a Gandini Weave if the weavers always pass in the middle of the figure 8 loop, although the Gandini’s have innovated many other interesting weaves besides just these variations. We don’t know if that is what the Gandini’s call them! This is a simple Gandini Weave that is a great foundation for other patterns.

In this weave all the weavers move in a figure 8, but they always pass from the middle instead of the end. To make the weave slow enough to be under control the feeder will pass twice in a row to each mover.

The feeder is in 2-count (every right hand pass), the feedees throw 2 right hand passes in a row, and then 4 right hand selves (PPSSSS).

Juggler/beat	1	2	3	4	5	6
A	B	B	C	C	D	D
B	A	A				
C			A	A		
D					A	A

It's easiest to start with the weavers stacked in a line all facing the feeder. * The feeder (A) passes twice to the first weaver (B), then that weaver goes to the right. * The feeder passes twice to the second weaver (C), then that weaver goes to the left. * The feeder passes twice to the third weaver (D), then that weaver goes right. * Now repeat where each weaver passes to the feeder and then moves in the opposite direction of the previous weaver.

This weave can be done in many interesting variations. * Try adding an extra club and making all the passes as doubles, or passing chocolate bar. * You can also invert the weave (reverse cascade). * Try this weave in 6-count with only a single pass to each weaver if you want a challenge that will really make you break a sweat.

We learned about this family of weave variations from juggling with Sean Gandini and the Gandini Juggling Project in 2000.

Three Leaf Clovers

The clover leaf patterns have a juggler on each *leaf*, and one in the middle, all moving. As the pattern progresses, the juggler in the middle trades places with a juggler on a leaf, *pushing* that juggler out of his/her leaf and back into the middle towards the next leaf in the sequence, and passing along the way. There are a different ways to make this work, but the following has become our default.

Standard Clover

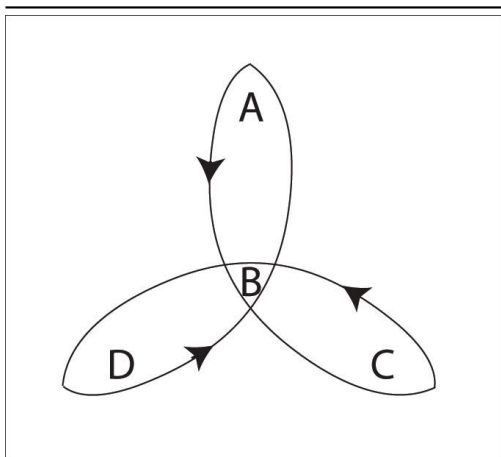

Juggler	1	2	3	4	5	6	7	8
A	D	B	C			B		
B		A			C	A	D	
C			A	D	B			D
D	A			C			B	C

Right-hand counting

In the standard version, there is a feeder who passes 3 times in a row (once to each of the other jugglers; from right to left). Then the former feeder has 2 right hand selves to move to the middle, one pass in the

middle, and 2 right hand selves to move out of the middle. Then the pattern repeats. We say it's *2-in-2-out*, as that counts the right selves on the way through the middle.

To start, ignore the fact that there is a clover. Just concentrate on the feed, and then moving into the middle of a feed and then moving out and repeating the feed. After the feed, as you start your *2-in*, it's helpful to move forward and slightly to the right while simultaneously rotating to the right (clockwise, from above); this helps you open up to be ready to be the middle pass in the next person's feed.

Just remember, feed, 2 selves-in-pass-2-selves-out. In the diagram above, A is the first feeder. In 8 passes, the clover has completed a cycle where every juggler has moved from their leaf to the next leaf. A full cycle is 24 right-hand beats (3 leaves times 8 beats per leaf).

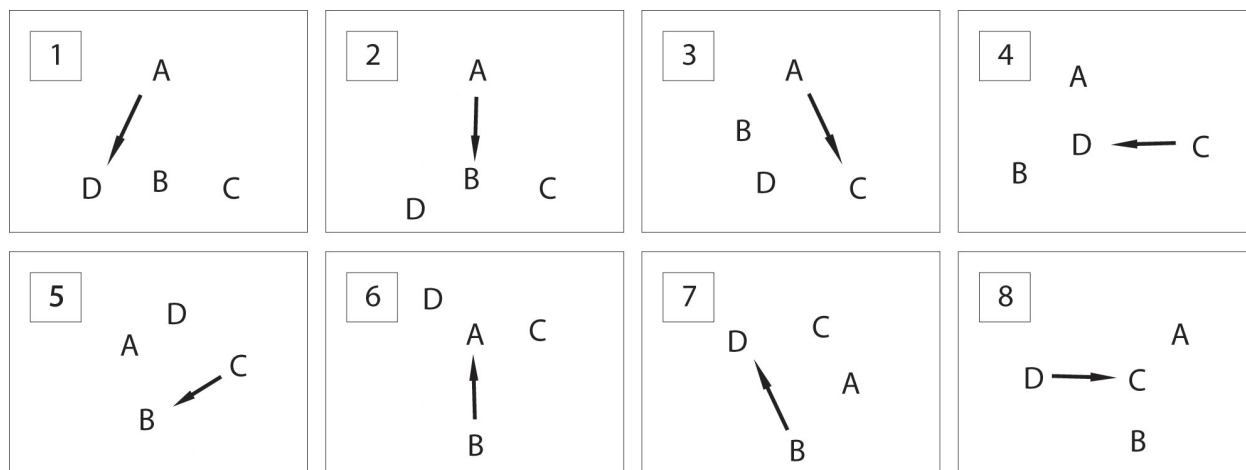

There's a beautiful symmetry to the pattern once it gets going. I hope you enjoy it as much as we do!

Mike Newton created this pattern in 2000.

Variations:

Try it in 3-count or chocolate bar. There are extensions that add clubs, people, and variations that change the passing sequence.

Run Over Clover

The Run Over Clover is the same pattern (as the standard clover) with some of the selves replaced with passes.

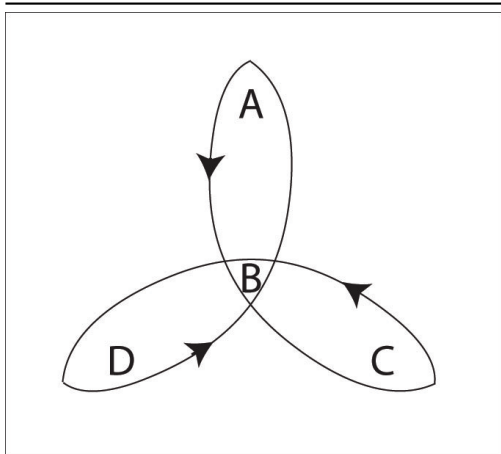

Juggler	1	2	3	4	5	6	7	8
A	D	B	C	B		B		B
B		A		A	C	A	D	A
C		D	A	D	B	D		D
D	A	C		C		C	B	C

Right-hand counting

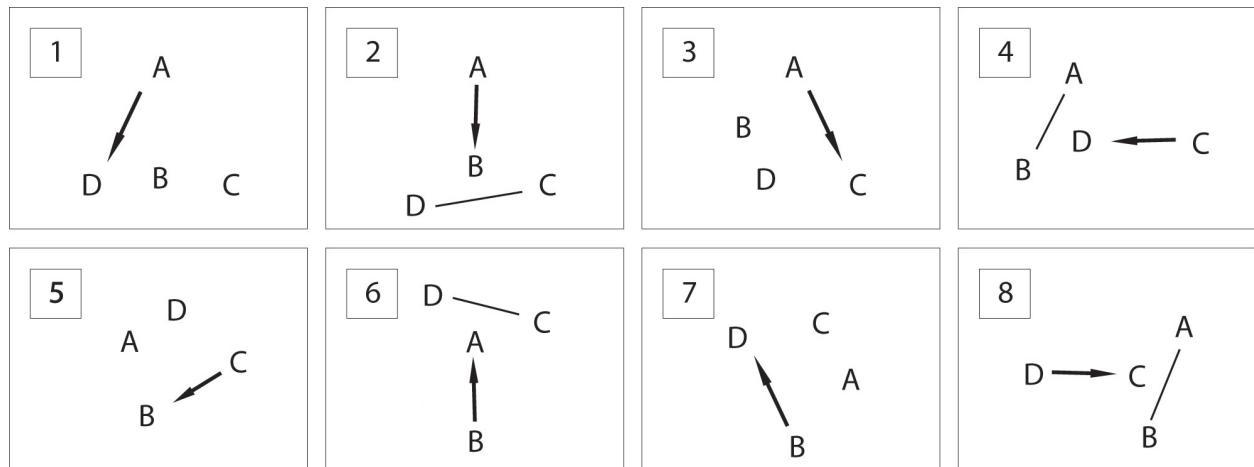

Created in 2001 by Mike Newton and the MAJ.

Extra-Club Three Leaf Clover

This is the standard three leaf clover with an extra club added and all passes as doubles. As usual, there are a number of ways to add a club. Here is a slower version that is a little easier. The feeder passes twice to the 2nd and 3rd feedees. The Hyper Clover is a faster and more elegant (but much harder) relation.

All passes are right hand straight doubles. A right to left double self is required to keep the timing.

Juggler/beat	1	2	3	4	5	6	7	8	9	10	11	12
A	D-D		D-B		D-B		D-C		D-C		D-self	Pause
B				D-A		D-A		D-self	Pause			
C	D-self	Pause						D-A		D-D		D-D
D		D-A		D-self	Pause						D-C	
Juggler	13	14	15	16	17	18	19	20	21	22	23	24
A						D-B		D-B		D-self	Pause	
B			D-C		D-A		D-A		D-D		D-D	
C		D-B		D-B		D-self	Pause					
D	D-C		D-self	Pause						D-B		D-C
Juggler	25	26	27	28								
A												
B	D-self	Pause										
C	D-D		D-D									
D		D-C		D-A								

- Both hands counting, right hand passes only
- A and C start with R
- B and D start with L

Hmmm... this is the first time that pattern has been written down. It isn't really as complicated as it looks. Let's walk one juggler through it.

1. Feed from right to left in doubles. Pass once to the end, twice to the middle, twice to the other end.
2. Self double, pause.
3. Two right selves to move into the middle, then pass twice
4. Self double, pause

5. Two right selves to move out of the middle
6. Repeat!

It's good fun if you're comfortable weaving while throwing doubles. Make sure your double selves are high enough to maintain the timing of the pattern.

Pattern by Luke Emery, 2001.

Hyper-Clover

Juggler/beat	1	2	3	4	5	6	7	8	9	10	11	12
A		D-B		D-C		D-self	Pause		D-B		D-self	Pause
B	Pause		D-A		D-self	Pause		D-A		D-D		D-self
C		D-self	Pause		D-D		D-B		D-self	Pause		D-D
D	D-A		D-self	Pause		D-C		D-self	Pause		D-C	

- Both hands counting, all right hands are double passes or double selves
- A starts with left hand
- B starts with pause, then left hand (for start, B can just start with right self)
- C starts with left hand
- D starts with right hand and 4 clubs

It's a great pattern but quite challenging.

This was one of the first extra club clover variations we tried. (The first attempt was me, Peter and Luke and Ilka from Luka Luka at a juggling convention.) Peter, Luke and Ilka are all fantastic club passers, but we discovered that this pattern was actually quite hard to do. That was the motivation to create the slower version described previously. However, after practicing and performing the Extra Club Clover for a few years, we were finally able to learn the original variation too, now renamed to the Hyper-Clover.

Pattern by Luke Emery, 2001.

Mike's Original Clover

Here's another version of the 4 person clover. However, we juggle the Standard Clover more often (which used to be called the New Clover) because it is easier to remember and has a nicer flow to it. Local cycle is 8 beats and full cycle is 24.

Juggler/beat	1	2	3	4	5	6	7	8
A	B	D		C		D		
B	A	C		D		C		
C	D	B		A		B		
D	C	A		B		A		

- Right hand counting

Every juggler is a feeder passing a standard 4-count feed to the other 3 jugglers. Performed by Mad-5 at 1998 Madfest.

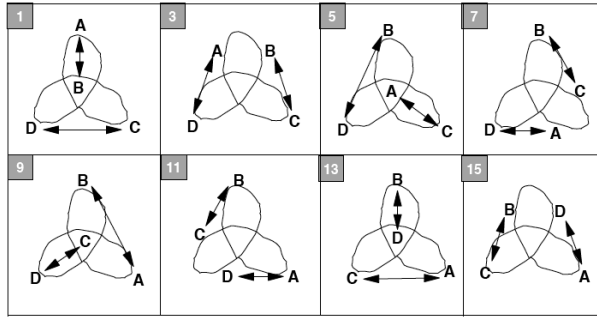

Peter’s Clover

The MAJ juggles the Standard Clover more often than this version. This is a nice pattern, if you can remember the passing sequence.

Juggler/beat	1	2	3	4	5	6	7	8	9	10	11	12
A	B	C	D	B	D	C	B	C	D	B	D	C
B	A	D	C	A	C	D	A	D	C	A	C	D
C	D	A	B	D	B	A	D	A	B	D	B	A
D	C	B	A	C	A	B	C	B	A	C	A	B

- Right handed 4-count

In the graph below, lines indicate passes, and arrows indicate the movement of jugglers after the pass.

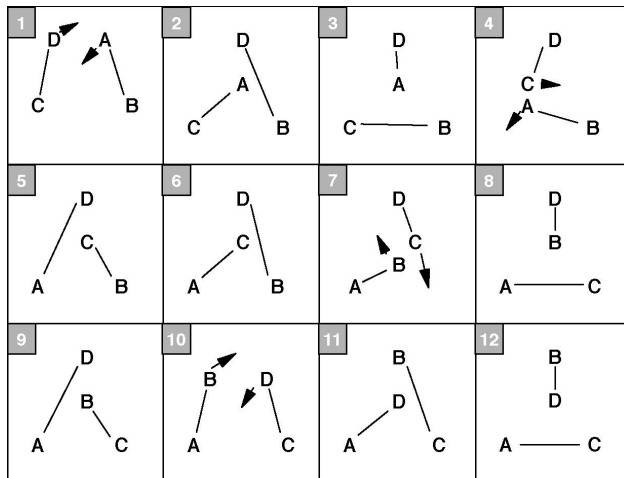

Notice that the movement around the leaves in Peter’s version is reversed from Mike’s original and Steve’s version. (The starting positions are also different). It takes 12 passes for everyone to move to the next leaf.

Every juggler is a feeder in a modified typewriter feed.

Steve’s Clovers

Here’s another way to configure clover passes, though it hasn’t garnered the adoration of the standard clover.

Inside Passing Triangles

Juggler/beat	1	2	3	4	5	6	7	8
A	B	D	C	D				
B	A	C	D	C				
C	D	B	A	B				
D	C	A	B	A				

- Right hand passing 4-count

Outside Passing Triangles

Juggler/beat	1	2	3	4	5	6	7	8
A	B	D	C	D				
B	A	C	D	C				
C	D	B	A	B				
D	C	A	B	A				

- Right hand passing 4-count

Alternate Inside/Outside Passing Triangles

Juggler/beat	1	2	3	4	5	6	7	8
A	B	D	C	D				
B	A	C	D	C				
C	D	B	A	B				
D	C	A	B	A				

- Right hand passing 4-count

The movement graph below applies to the three versions above. Lines indicate passes. Arrows indicate movement of jugglers after the pass.

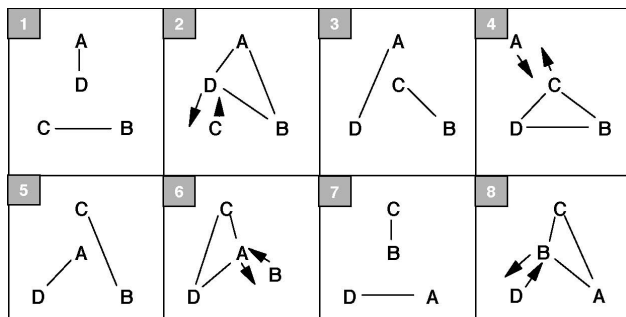

The passing rate and movement along the leaves is the same as in Mike's original version. In Steve's version, for the odd numbered passes, A and D always pass to each other, and B and C always pass to each other. For the even numbered passes, three jugglers pass to each other in a triangle. The juggler not in the triangle will be bumped off its leaf. You get three variations based on inside-only, outside-only, or alternating passes.

Spinny patterns

Benzene Ring (Four Juggler Version)

There is a whole family of benzene ring patterns, where movers juggle in a circle between two feeders. The Benzene Ring for Six and for Eight are easier patterns to learn, but Benzene Ring for Four is more fun.

This version is in 3-count. Now we usually call this Spinning 3-count.

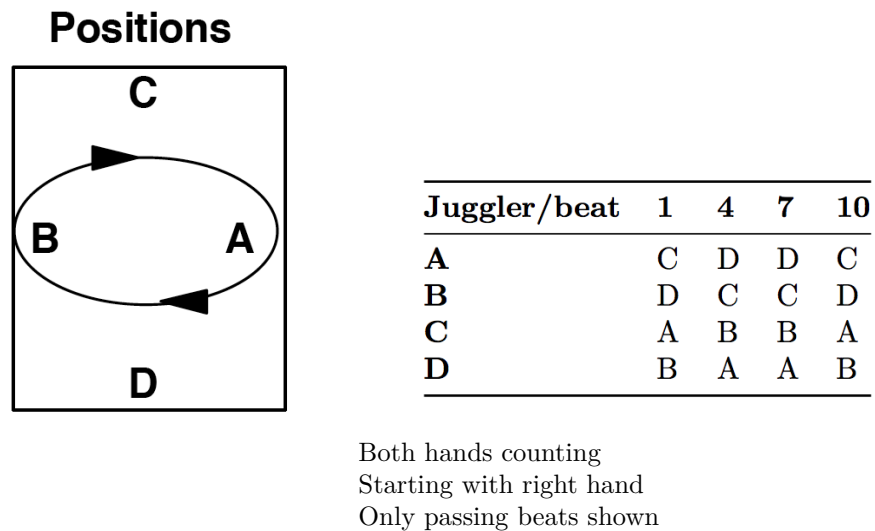

After the first pass (throw #1 in the graph, made with the right hand), A and B have 2 self throws to turn around. If C and D make their right hand passes deep, A and B will have an easier time turning.

After the second pass (throw #4 in the graph, made with the left hand), A and B have 2 self throws to switch places. They switch places by moving around each other in a counter clockwise direction.

After the 3rd pass (throw #7 in the graph, made with the right hand), A and B have 2 self throws to turn around.

After the 4th pass (throw #10 in the graph, made with the left hand), A and B have 2 self throws to switch places. The jugglers are at their original positions. At this point, the pattern repeats.

This pattern is fast for the movers A and B because they are passing 3-count while spinning around each other.

This pattern could be considered a 2-seated unicycle without the seats, going backwards. It is a precursor for the Razor juggling pattern.

Pattern created July, 1997 by MAJ. Performed by Peter, Mel, Mike and Dan at Madfest 1998.

Chocolate Stir

A chocolate bar variation of the 4 person Benzene Ring starts in the same positions as the Benzene Ring. Each juggler is in chocolate bar. The inner jugglers throw right pass, left pass, then right to left single and do a half pirouette underneath, followed by a left self and then repeat.

Positions

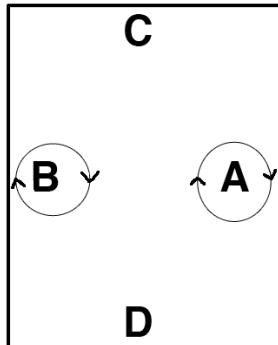

Juggler/beat	1	2	3	4	5	6	7	8
A	D	D	½ P		C	C	½ P	
B	C	C	½ P		D	D	½ P	
C	B	B			A	A		
D	A	A			B	B		

Both hands counting
 Starting with right hand
 Only passing beats shown

- The ½ P marks a half pirouette under a single spin right to left self. A and B spin in place.

Pattern by Luke Emery

$2\pi/3$ With Post

Take the 3-person $2\pi/3$ pattern, but add a stationary *post* who feeds the same count as everyone else, but alternating to positions 2 and 5.

Canoe

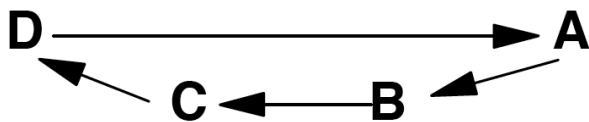

- A is facing B, C, and D.
- B, C, and D are facing A.
- B and C pass dropbacks.
- Use your favorite passing sequence.
- Arrows indicate passes.

We don't know who invented this pattern, but we have been doing it since 1993. You can easily add extra clubs or people and use a variety of passing counts.

Death from Above

This is a fun but challenging pattern with 2 extra clubs. It requires two jugglers that are comfortable with 7 clubs 4-count back to back passing and who aren't pansies like some Madison Area Jugglers I could mention.

A faces B, and C faces D.

Juggler/beat	1	2
A	T-D	S-B
B	T-C	S-A
C	S-D	T-B
D	S-C	T-A

- Right hand counting
- A and B start with 4 clubs each and start passing at the same time. C and D each start with 3 clubs.
- A passes triple to D, then single to B.
- B passes triple back-to-back to C, single to A.
- C passes single to D, triple back-to-back to B.
- D passes single to C, triple to A.

Pattern by Luke Emery, 1999.

Two-on-Two Double 3-Count

Everyone does double 3-count feed, feeding from right to left. This pattern is a prerequisite for El Nino [see later].

Juggler/beat	1	2	3
A	C		D
B	D	C	
C	A	B	
D	B		A

- Both hands counting
- Start with right-hand

This is the standard MAJ double 3-count box, but you might as well learn the opposite version (feeding from left to right) for doing the backwards El-Nino (La Nina).

[dates to 7/97 MAJ, maybe earlier by others]

Ultimate Feeds

One count feeds are fun by themselves but they also provide a foundation for other cool patterns, such as El Nino.

12 club standard 1-count feeds

A
B C D

Juggler/beat	1	2	3
A		B	C D
B		A	
C			A
D			A

Juggler/beat	1	2	3	4
A		B	C	D C
B		A		
C			A	A
D			A	

typewriter

Both-hands counting
start with right
windshield wiper

The typewriter form is a 3-count feed where A feeds a 1-count carriage return, and B, C, and D are passing 3-count. The windshield-wiper form has C doing 2-count lefts and the other feedees on 4-count rights. The typewriter can also be done backwards.

Not sure where these came from but we love them in Madison!

Ultimate Feed Plus

Add one extra club to the Ultimate feed by having all the feedees throw crosses. Alternatively (the feeder can throw crosses while the feedees throw straight). The extra club feed can be done with many different spins.

All passes in singles. (Timing is a bit wonky. Throw a little outside, especially on the middle throws.)

Feeder and feedees all in double passes. (Feeder rights synchronized with feedee lefts.) Feels like 7 club 3-count.

Feeder in triples ultimates, feedees in singles. (Feeder rights synchronized with feedee rights.)

Feeder in single ultimates, feedees in triples. (Feeder rights synchronized with feedee rights.)

Ultimate Feed Plus Plus

To add another club (14 total), throw all passes as doubles and all passes are straight from both feeder and feedees.

Theoretically you could keep adding more clubs and higher throws, and just switching back and forth from straight to cross feedee passes with each extra club, but it gets challenging quickly.

El Nino

El Nino is a rotating 1 count feed and is one of the crown jewels of the MAJ pattern book.

It is a challenging pattern, but quite doable once passers master the 1-count feed and the 2 on 2 double 3-count box. And once you can juggle it, you can join the Madison elite group of Jugglers Who Can Do The El Nino.

Juggler/beat	1	2	3	4	5	6	7	8	9	10	11	12	13	14	15	16	
A		C	D	B	C		B		C			C			D		
B				A		D	A	C	D		C		D			D	
C		A			A			B		A	B	D	A		D		
D			A			B			B			C		B	C	A	B

- Both hands counting
- All jugglers start with left hands

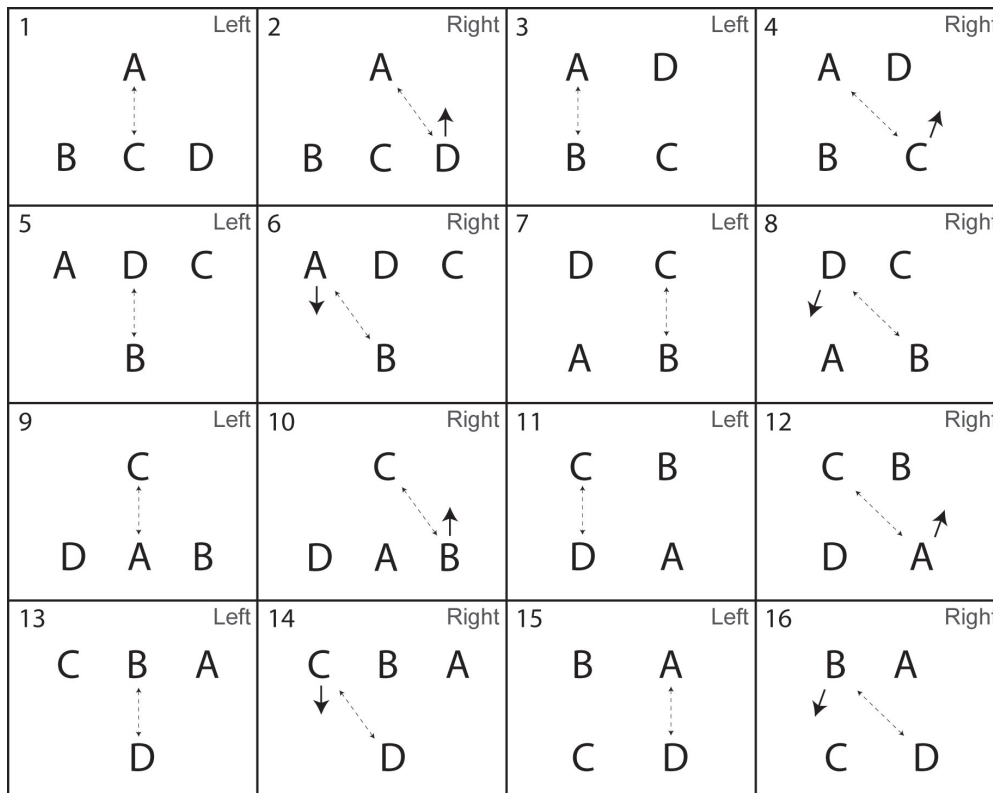

Positions: Lines indicate passes, arrows indicate movement of juggler after the pass.

El Nino is the combination of 2 patterns: Two on Two Double 3-Count, and Ultimate feed. Starting in the positions of the Ultimate Feed pattern, one of the feedees moves across and stands next to the feeder. Now the jugglers are doing Two on Two Double 3-Count.

Then another of the original feedees moves across, following the first mover, and the pattern becomes the Ultimate Feed again.

Now have 2 jugglers move back (one at a time) to join the feeder. See the diagrams above to see how the jugglers move.

The pattern in the graphs above is the fastest version. While learning, it's a good idea to wait a while, until the next juggler is ready, before the next move. Remember to move on a right hand pass.

The mirror image (1-count feeding left to right) is called La Nina. Move on left throws instead of rights and start with a right pass in the middle.

There are other fun ways to rotate a 1-count feed. Tarim demonstrated a pattern similar to 1-count El Nino where the mover transitions in 4-count instead of 3-count (leaving on a left hand throw in the above picture instead of a right, and joining the double three count box on the opposite count. He also goes the wrong direction like La Nina! :)

El Nino dates to August, 1997 by Peter Kaseman and MAJ, during the famous meteorological event¹.

¹https://en.wikipedia.org/wiki/1997%E2%80%939398_El_Ni%C3%B1o_event

El Nino Plus

Slow Version

	1	2	3	4	5	6
A	single L	single R	single L	single R	Self L	double R
B	Self L	double R	Self L	Self R	Self L	Self R
C	double L	Self R	Self L	Triple R	Self L	Self R
D	Self L	Self R	double L	Self R	Self L	Self R
Diagram						

Fast Version

	1	2	3	4	5
A	Double L C	Double R D	Double L B	Double R C	Self L A
D	single R A	self L D	Single R A	Crossing double Self L D	Pause — —
C	self R C	single L A	self R C	Self L C	Double R A
B	double self ring L B	Pause —	self R B	single L A	self R B
Diagram					

El Nino patterns by Graham Paasch. Q. Graham, where are the transitions?

El Turbo

A four-person turbo-fied version of El Nino. The idea is to cross through the center of the pattern when you make your change-side, as in the Turbo. It might not be theoretically possible in 1-count (the rate for El-Nino), so we usually do it in 2 count (right-handed). The pattern has 16 passing beats, and we usually count it 1-2-3-4 four times; each set corresponds to one person being the feeder. For example, in the figure below, the red juggler starts as the feeder. Notice, that beats 1 and 4 of each feed go to the same feedee. You'll notice that the pattern is *chiral*, as we say, which means that it has a specific orientation; a backwards version would be different. In the figure, for example, movement through the middle always goes left to right.

El Turbo (Madison, 8/25/11)

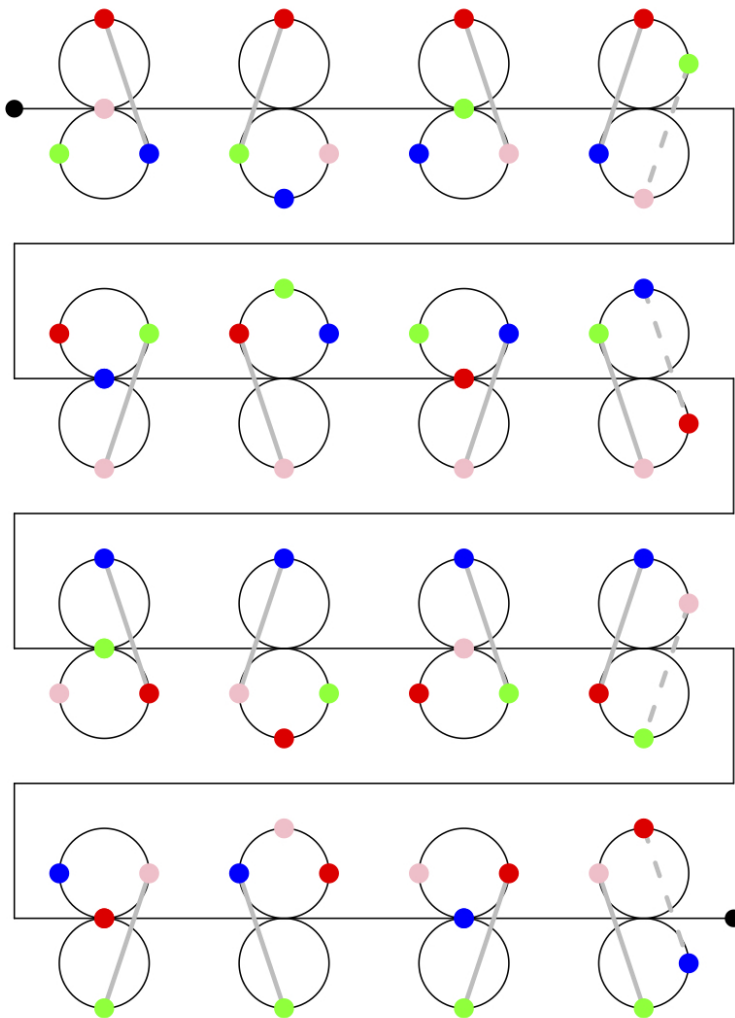

Variations: There are opportunities in El Turbo for extra passes (compared to El Nino) that have become available owing to the crossing of jugglers. These extra passes are noted with dashed grey lines in the figure above. Of course they're not required, but they're cool. There are also opportunities to pass to stationary jugglers on the left or right side of the pattern, making it a 5 or 6 person variant. These extra jugglers pass

4 count; we set the one on the right doing even beats: pass to pink on beat 2, green on beat 4, blue on 6, and red on 8 [i.e. after they come through the middle]. Then the passer on the left picks up the odd extra beats (e.g. green on 1, blue on 3, red on 5). Notice the left passer does two passes to one side of the El Turbo and then two to the other side, all on 4 count. Since the two stationary extra players are on alternating 4 counts they can add an extra club triple over the top to each other. We tried this extra-club once but it didn't really work!!

Tomahawk

This is an El Turbo variation. Slow down the 2-count El Turbo base count to 3-count; then tomify by replacing each *pass-self-self* with a *pass-pass-pass*. It has nice club color coordination like Tom's Turbo. It's pretty heavy duty; e.g. as you cycle into your feeder position you end up doing 1-count for 12 passes!

Oogle Boogies

Oogle Boogies are rotating Y patterns, with four jugglers passing multiple times then switching positions.

Original Oogle Boogie

Positions and passing directions

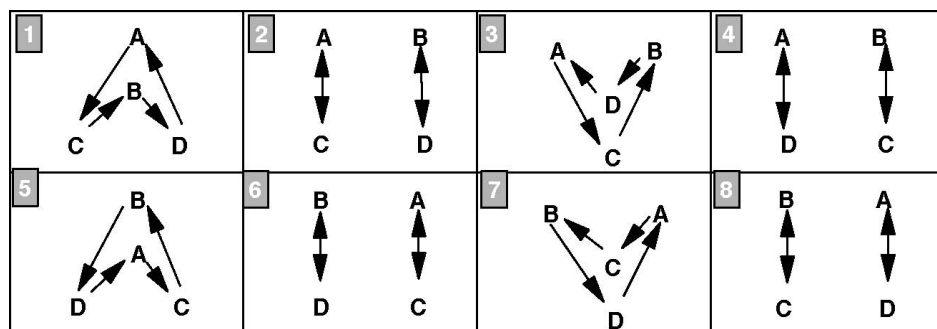

For each box, the jugglers will throw 3 right hand passes (two count) followed by a right hand self throw so they can move to the positions in the next box. The arrows are the directions of the passes. For example, in box 1, A passes to C, C passes to B, B passes to D, and D passes to A.

For the **Left Hand Version of Oogle Boogie**, use the same positions but reverse the direction of all of the arrows and rearrange the order of the boxes as 1,8,7,6,5,4,3, and 2.

For **Three Count Oogle Boogie**, use the positions in the diagram above. Instead of the arrows, use the table below to determine where to pass. Notice that the table below does not show beats 2,3,5,6,8,9, Assume that all beats not in the table are self throws.

The first 3 passes, i.e. on beats 1, 4, and 7, are done in the positions in box one above. The next 3 passes, i.e. on beats 13, 16, and 19, are done in the positions in box two. Continue assigning 3 passes to each box. After the 4th box, you will be at the end of the table below. For the boxes 5 through 8, start again at the beginning of the table below.

Juggler/beat	1	4	7	10	13	16	19	22	25	28	31	34	37	40	43	46
A	C	D	C		C	C	C		C	D	C		D	D	D	
B	D	C	D		D	D	D		D	C	D		C	C	C	
C	B	A	B		A	A	A		B	A	B		B	B	B	
D	A	B	A		B	B	B		A	B	A		A	A	A	

Try the above in a ‘pass, pass, self’ pattern. Each box in the position table will have 6 passes before changing positions for the next box. This is a difficult pattern.

Fast Oogle Boogie

Use only the position boxes 1, 3, 5, and 7, and follow the passing directions indicated by the arrows. Remember to pass 3 times with the right hand, using the 4th right hand self to switch positions. This is the version we usually do.

Notice that the passes are always from A to C, B to D, C to B, and D to A.

When was this pattern created? We have been doing it since 1991; the Mad-5 performed it at Madfest 1997.

14 Club Oogle Boogie

This has the same movement sequence as the standard Oogle Boogie, but with 2 extra clubs so all the passes are doubles (like 7 2-count).

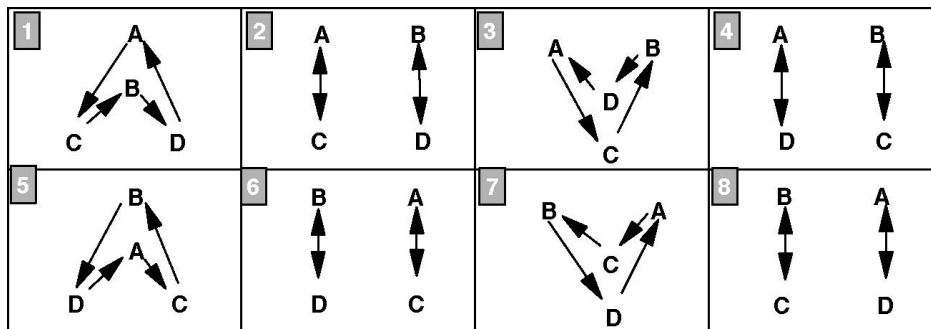

Position 1: C, D start with 4 clubs each, do 3 passes, then triple self. A, B start (1/2 beat after C and D) with 3 clubs each, do 3 passes, then move to position 2.

Position 2: A, B do 3 passes, then triple self. C, D do 4 passes, then move to position 3.

Position 3: A, B do 3 passes, then triple self. C, D do 3 passes, then move to position 4.

Position 4: A, B do 4 passes, then move to position 5. C, D do 3 passes, then triple self.

All passes are double spin passes. Four passes are needed to transfer the extra clubs to the team that is not moving.

It’s probably helpful to be comfortable with 7 club popcorn variations before learning this pattern.

It’s possible to do a regular fast Oogle Boogie instead of the slow version if you have jugglers that are comfortable moving while throwing self triples.

Pattern by Luke Emery, 2000.

Luke’s Oogle

This is a Y in 3-count. Odd numbers are right hand passes and even numbers are left passes.

Juggler/beat	1	2	3	4
A	C	D	C	D
B	D	C	A	A
C	B	A	D	B
D	A	B	B	C

- 3-Count
- Start with R
- B does drop backs to A

If you have 4 jugglers that can do every position, then you can try the following:

Four position graphs are depicted below. Starting with the first position, perform 4 passes (one cycle) and use your 2-self throws to move to the positions in the next graph. Four passes are made in every position.

The kind of rotation that the jugglers are doing in the variation above is the same as in the fast Oogle Boogie pattern, also known as the rotating-Y.

Pattern created in 1998 by Luke Emery.

Slingshot

This is a 14 club variation on the Y pattern (Oogle) where all of the right hands are synchronized.

Juggler/beat	1	2
A	C	T-D
B	T-D	C
C	A	B
D	T-A	T-B

Right hand counting

B and D start with 4 clubs each, and A and C start with 3 each.

D feeds A and B with 2-count triples (like 8 club 2-count).

C feeds A and B with 2-count singles (standard feed).

A and B alternate triple passes to D and single passes to C.

Every juggler is feeding two other jugglers: A and B are feeders to C and D, and C and D are feeders to A and B.

By Peter Kaseman, 1999.

Slingshot Minus

Here's an easier version with only one extra club. All passes are in a 4-count.

Juggler/beat	1	2	3	4
A	C		T-D	
B	T-D		C	
C	A		B	
D		T-A		T-B

- Right hand counting and passing
- B starts with 4

Slingshot Plus

You can make the pattern more interesting by adding clubs in the middle. With one more club C feeds an extra club line in doubles.

Juggler/beat	1	2	3	4
A	D-C		T-D	
B	T-D		D-C	
C		D-B		D-A
D	T-A		T-B	

- Both hands counting
- All passes with right hand
- A, B and D start with 4 clubs and right hand
- C starts with 3 clubs and left hand

Slingshot Plus Plus

Ok, while we're at it, you can add another club (so that all right hands are triple passes) to get the following:

Juggler/beat	1	2
A	T-C	T-D
B	T-D	T-C
C	T-B	T-A
D	T-A	T-B

- Right hand counting
- All passes with right hand
- All passers start with 4 clubs

This works best if all the jugglers are quite comfortable with 8 club 2-count in triples.

Created June, 1999 by MAJ.

Martin's Madness/Mildness

After we learned Martin's Madness, we put 4 jugglers in the positions shown and tried to figure out if all 4 jugglers could be the feeder as in Martin's Madness at the same time. The pattern below is what we ended up with.

Juggler/beat	1	2	3	4	5	6	7	8	9	10	11	12
Al	*	Cr		s		Dr	s		Dr		Cr	
Ar	s		Dl		Cl		*	Cl		s		Dl
Bl		Dr	s		Dr		Cr		*	Cr		s
Br	Cl		*	Cl		s		Dl	s		Dl	
Cl		Al		Bl		*	Bl		s		Al	s
Cr	Br		s		Ar	s		Ar		Br		*
Dl		Bl		*	Bl		s		Al	s		Al
Dr	s		Ar	s		Ar		Br		*	Br	

- Legend: Al = left hand of A
- Cr = right hand of C
- * = handoff
- s = self pass

Notes: * A and B are doing Martin's Mildness, out of sync. (straights) * C and D are doing Martin's Madness, out of sync. (crosses) * A and D are in sync, as are B and C.

Martin Frost created Martin's Madness and the variation on this page dates to 4/98 by MAJ. Martin has innovated many interesting feeds and other patterns, often with hurries and zips. Look them up, or best of all, find a Stanford juggler to help out.

Also see the 3 person Siteswap Feeds.

Popcorn Feed

Recall that a popcorn pattern between 2 jugglers is a 7 club pattern where the jugglers are passing a beat out of sync. With the right hand, each juggler passes a double spin to partner, a single spin to self, and a triple spin to self. The left hand throws are all single spin self throws.

The Popcorn Feed is a 14 club pattern where A is out of sync with B, C, and D. A and B start with 4 clubs each, and B and C start with 3 each. A does a typewriter feed in doubles. B, C, and D all do a standard 6-count popcorn.

Juggler/beat	1	2	3	4	5	6
A	D-D		D-C		D-B	
B		D-A		self		T-self
C		self		T-self		D-A
D		T-self		D-A		self

- Both hands counting
- A starts with R and 4 clubs
- C, D start with L
- B starts with 4 clubs and a pause, then right throw on 2

This is a spectacular pattern, and could be a basis for an El Nino.

Low Popcorn Feed

This feed can be done with single passes and double selves instead of doubles and triples.

Popcorn Weave

Like most feeds, this can be turned into a weave. The feeder throws windshield wiper feed instead of typewriter feed. The feedees throw a triple self, then a double pass, then move to the next weave position on their self. This is a challenging weave. Also see the Popcorn Twister and Popcorn Twister Weave.

This pattern dates to September, 1999 by Luke Emery and the MAJ.

Simple Egg Beater, No Handle

This is like a 4-person version of a synchronous double weave.

Positions

Juggler/beat	1	2	3	4
A	C		D	
B	D		C	
C	A		B	
D	B		A	

positions
Right hand counting

After the 4th beat, the jugglers are inverted, but the passing sequence repeats.

This pattern dates to 1997 by Mike Newton and MAJ, but it took us a while to recognize it is an egg-beater without a handle!

Unicycle

The unicycle is a nice moving pattern in 3-count.

12 club

Positions

Juggler/beat	1	4	7	10
A	C	D	D	C
B	A	A	A	A
C	B			B
D		B	B	

* Both hands counting

* Start with right hand

* A is the seat, B is the stem, and C and D are the wheel.

- * A and B face C and D. C and D move around the circle in a counter-clockwise direction
 - * Passes are done on 3-count.
 - * All passes from B to A are drop-backs.
-

Unicycle dates to 1996 by MAJ. Performed by Mad-5+1 at Madfest 1999.

Unicycle Plus

Positions

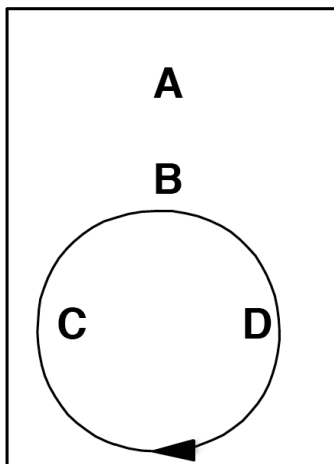

This is a fun moving pattern in 4-count with triple passes, double passes and dropbacks.

A feeds the left and right positions with 4-count triples.

B always throws dropbacks to A in 4-count.

C and D each throw 2 double passes to B in 4-count from the left position and then the right position, and then have 4 right hand counts to move around the back of the circle to the start.

Juggler/beat	1	2	3	4	5	6	7	8	9	10	11	12	13	14	15	16
A			T-C				T-D				T-D					T-C
B		D-A				D-A				D-A				D-A		
C	D-B				D-B											
D									D-B				D-B			

- Both hands counting – all passes with right-hand
- C starts with 4 clubs and right-hand
- B starts with left-hand
- A and D start with right-hand selves

Y2K

Positions

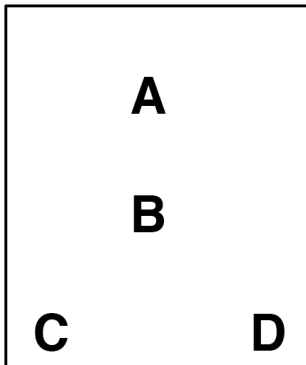

This pattern has synchronous 1-count passes from A and synchronous dropbacks from B to A. A and B throw simultaneously with the left and right hand. It might take some practice to be comfortable catching those crazy passes!

B starts with 4 clubs and passes 2 at a time to A.

A starts with 2 clubs and passes 2 at a time:

Right hand passes to C's left hand.

Left hand passes to D's right hand.

C passes every right hand to the "C" side of B (B's right hand) in right handed 2-count.

D passes every left hand to the "D" side of B (B's left hand) in left handed 2-count.

If B is facing C and D, then B passes simultaneous drop-backs to A, C passes to B's right hand, and D passes to B's left hand.

At B's discretion, B will rotate and face A.

B will now pass 2 at a time straight to A.

C passes drop-forwards to B's left hand.

D passes drop-forwards to B's right hand.

Have B rotate in the pattern until dizzy, then switch positions so that everyone has a chance to experience the problems associated with Y2K.

This pattern was created by Mike Newton on December 31, 1999.

Gorilla for Four

This is one variation on gorilla passing with 4 passers.

There are 13 clubs. X starts with 4. A, B and C start with 3.

X throws synchronous ultimates. B throws right handed 2 count. A and C throw right handed 4 count. Here is the pattern.

X starts by throwing synchronous ultimates to B's left hand and C's left hand. Then X throws synchronous ultimates to A's left hand and B's left hand. And repeat.

B starts a little after X's first throws, with a right hand throw to X's right hand, then the next right hand throw is to X's left hand. In the steady state, B alternates feeding X's right hand and X's left hand with 2 count right hand throws.

C starts a little after X's first throw (in time with B) and throws to X's right hand. After that, C is always doing 4 count with X's right hand.

A starts a little after X's first throw with a right hand self. After that, A does 4 count with X's left hand.

Pattern by MAJ.

Anklet (for 4 jugglers)

Argyle sock minus 2 jugglers.

Juggler/beat	1	2	3	4	5	6
A	B	D		C	D	
B	C	C		A	C	
C	A	B		B	B	
D		A			A	

- Both hands counting

Variation: Try making D spin.

Pattern by MAJ.

Rush and Rest

This is a four-person pattern using right and left hand passing where each juggler passes four out of six throws.

Classic Rush and Rest

Juggler/beat	1	2	3	4	5	6
A	B	C	B		D	
B	A	D	A		C	
C		A		D	B	D
D		B		C	A	C

- Both hands counting

First Variation

This is a Feast pattern with an extra pass across and an extra pass to self.

Juggler/beat	1	2	3	4	5	6
A	B	B	C			D

Juggler/beat	1	2	3	4	5	6
B	A	A	D			C
C			A	D	D	B
D			B	C	C	A

- Both hands counting

Second Variation

A and B repeat the passing rhythm in the classic Rush and Rest. C and D pass for two beats, rest for one beat.

Juggler/beat	1	2	3	4	5	6
A	D	D	B		C	
B	C	C	A		D	
C	B	B		D	A	
D	A	A		C	B	

- Both hands counting

Rush and Rest is by Steve Otteson and MAJ from 1998.

Shooting Star

In a Star pattern five jugglers stand in a circle and pass to the second juggler to the right. A Shooting Star is a star with one juggler missing. When each juggler runs out of clubs, they move to the empty space.

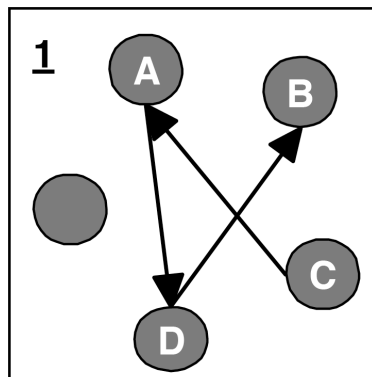

1. A, C, and D start with 3 clubs and pass according to diagram one. When C runs out of clubs, C moves to the empty spot.
2. A will run out of clubs next and then move to the empty spot. The pattern continues so that each juggler will run out of clubs and move to the empty spot.

Tip: Move to the center as you throw your last club after a club whizzes by the front of your head. Turn around. Move out as the next pass whizzes by the back of your head.

There are many variations on the shooting star. Add multiple clubs and up the passes to doubles and/or triples. Pirouette through the middle

Shooting Star was created by Bryan Olson in 1993 (not in Madison!!).

14 Club Lines (for 4 jugglers)

Here are some of the many 4 juggler line variations we do in Madison. A and B are both facing C and D.

Locked Lines

Juggler/beat	1	2	3	4
A	D-C		D-C	
B	D-D		D-D	
C		D-A		D-A
D		D-B		D-B

- Both hands counting, right hand passes only
- A and B start with 4 and right hand
- C and D start with 3 and left hand

To avoid dangerous collisions, A and B should throw at exactly the same time, and C and D should throw at exactly the same time. A and D can control the timing the best since they have the best visibility.

Popcorn Lines

Juggler/beat	1	2	3	4
A		T-self		D-C
B	D-D		C	
C	D-A		B	
D		T-self		D-B

- Both hands counting, right hand passes only
- B and C start with 4 and right hand
- A and D start with 3 and left hand

Popcorn Lines 2

Juggler/beat	1	2	3	4
A		T-D		D-C
B	D-D		C	
C	D-A		B	
D		T-D		D-B

- Both hands counting, right hand passes only
- B and C start with 4 and right hand
- A and D start with 3 and left hand

You can switch back and forth between the Popcorn Line variations.

Popcorn Dropback Line

The popcorn dropback variations work better if B and C move a little to the side in more of a diamond formation than a line.

Juggler/beat	1	2	3	4	5	6
A	D-C				T-self	
B		T-self		D-A		
C		T-self		D-D		
D	D-B				T-self	

- Both hands counting, right hand passes only
- A and D start with 4 and right hand
- B and C start with 3 and left hand and throw all dropbacks as doubles

Popcorn Dropback Line 2

Now add triple passes over the top!

Juggler/beat	1	2	3	4	5	6
A	D-C				T-D	
B		T-C		D-A		
C		T-B		D-D		
D	D-B				T-A	

- Both hands counting, right hand passes only
- A and D start with 4 and right hand
- B and C start with 3 and left hand and throw all dropbacks as doubles

To start, add one set of triple passes at a time.

Popcorn Dropback Line 3

Ok, add in some more extra passes. Why not?

Juggler/beat	1	2	3	4	5	6
A	D-C				T-D	
B		T-C		D-A		C
C		T-B		D-D		B
D	D-B				T-A	

- Both hands counting, right hand passes only
- A and D start with 4 and right hand
- B and C start with 3 and left hand and throw all dropbacks as doubles

Chapter 5

5-Person Patterns

Apollos

Original Apollo

The original Apollo (also known as the 1-1-3 Apollo) is an MAJ standard.

					Juggler/beat	1	2	3	4	
A					A	E			C	
	B				B	C	D	E	D	
		C			C	B			A	
			D				D	B	B	
	C	D	E					E	A	B

positions Right-hand counting

Cockeyed Apollo

Change the outside throws to be in a Y and the Apollo becomes cockeyed...so named because the middle feeder (B) has to throw and catch from opposite directions. Notice the switcheroo in the passing table for jugglers C and E.

					Juggler/beat	1	2	3	4	
A					A	E			C	
	B				B	C	D	E	D	
		C			C	A			B	
			D				D	B	B	
	C	D	E					E	B	A

positions Right-hand counting

Apollo Plus

A and D can pass an extra club (triple spin) over the pattern on their right hand self throw. D starts with the extra club. This variation works well with the standard Apollo, but is hair raising with the Cockeyed Apollo. If that's not exciting enough, add another club to the inner feed (all those passes are doubles) so it is a 2-count extra club feed.

Apollo Plus Weave

Here's a nice weave pattern (see later for more on weaves). Start with the 1-1-3 Apollo formation and have B feed a standard weave of C, D and E. Then A can add an extra club and throw 4-count triples to the ends. (A starts with 4 and a triple to whichever end B doesn't start with.)

All the weavers will have the following sequence (starting from the outside) B, self, self, B, self, Triple to A, B.

Also see the 1-2-3 Apollo for 6 jugglers and the 1-2-4 Apollo for 7 jugglers.

The Apollo was invented by N.A.S.A. The Apollo juggling pattern was invented by the Gemini Jugglers in 1991.

Chocolate Feeds

These are fun 5 person stationary patterns, with 2 feeders and 3 feedees, originally in opposing lines (standard positions) or in the more uncomfortable wedgie positions, which used to work well when we juggled on chairs in 3650 Humanities!

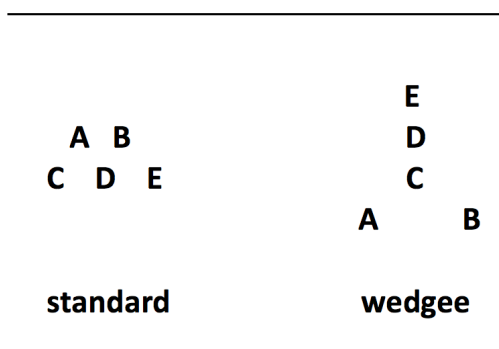

Chocolate Bar 3-Count Feed

The Chocolate Bar 3-count feed shares a 1-count feed between two feeders.

Juggler/beat	1	2	3	4	5	6	7	8	9	10	11	12
A	C	D			D	E			E	C		
B			E	C			C	D			D	E
C	A			B			B			A		
D		A			A			B			B	
E			B			A			A			B

- Both hands counting, right hand starts

Aidan Quinn worked out an extra club variation of this pattern. See his web site under the Passing Resources

section for more information. Basically the feeders share an extra club ultimate feed, alternating two passes as chocolate bar. Feeders pass straight and feedees pass cross.

A version with 2 extra clubs should be theoretically possible, with all passes straight doubles.

This pattern is also called the Chocolate Box. See ¹

Pattern by Steve Otteson and MAJ; performed by Mad-5 at 1997 Madfest and elsewhere.

Double Chocolate Double 3-Count Feed

Another pattern using the 2-facing-3 or wedgie positions.

Juggler/beat	1	2	3
A	C	C	D
B	E	D	E
C	A	A	
D		B	A
E	B		B

- Both hands counting
- Right hand starts

Notice that the first 3 throws are R-L-R, and the next 3 throws are to the same people but are L-R-L.

Pattern by Steve Otteson and MAJ. Performed by Mad-5+1 at 1999 Madfest.

Semi-Sweet Chocolate 3-Count Feed

As far as the number of passes made by A and B go, the Semi-Sweet pattern is in between the Chocolate Bar and the Double Chocolate Bar patterns. Also uses the 2-facing-3 or wedgie positions.

Juggler/beat	1	2	3	4	5	6
A	E	C		E	D	
B		D	C		E	C
C		A	B			B
D		B			A	
E	A			A	B	

- Both hands counting, right hand starts

In early versions of the passing book this was called *The New One*. Pattern by Mike N.

Variation

¹<https://www.juggle.org/passing-post-feeding-on-chocolate-bars/>

Juggler/beat	1	2	3	4	5	6
A	C		E		D	
B		D		C		E
C	A			B		
D		B			A	
E			A			B

- Both hands counting, right hand starts

Pattern by Steve Otteson and MAJ.

Circles

There are lots of cool stationary patterns for five jugglers who are arranged equi-spaced around a circle.

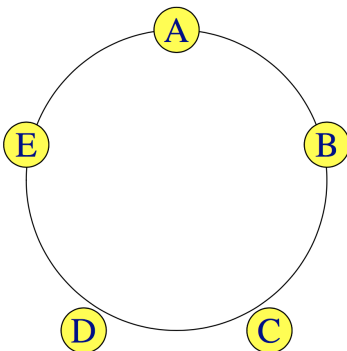

Feast (for 5 jugglers)

Everyone feeds everyone else!

Juggler/beat	1	2	3	4	5
A	B	C	D	E	
B	A		C	D	E
C	E	A	B		D
D		E	A	B	C
E	C	D		A	B

- Any count of your choosing.

Classic pattern. When were these patterns created? We have been doing them since 1992. Already this generalizes the standard Rotating Feed (which is not marked up here; we don't usually do it).

Variation: When on 3-count, try to **Picnic**. I.e., do one cycle on straight throws and the next on crossing throws. This creates some crazy Jim's jams.

Extra Club Rotating Feed

Any feed or feast can be done with an extra club by throwing passes as doubles and following every feedee pass and every feeder cycle with a self double to restore the timing. A right to left self double switches left and rights.

This pattern is also in a star. A is the first feeder. This feed is shown clockwise, but of course it could work either direction.

Juggler/beat	1	2	3	4	5	6	7	8	9	10	11	12	13
A	D-C		D-D		D-E		D-self	Pause					D-D
B		D-self	Pause				D-E		D-self	Pause			
C		D-A		D-self	Pause				D-E		D-self	Pause	
D				D-A		D-self	Pause				D-A		D-B
E	D-self	Pause				D-B		D-C		D-D		D-self	Pause
Juggler	16	17	18	19	20	21	22	23	24	25			
A				D-C		D-self	Pause						
B	D-self	Pause				D-D		D-E		D-A			
C	D-E		D-A		D-B		D-self	Pause					
D		D-self	Pause				D-B		D-self	Pause			
E		D-C		D-self	Pause				D-B				

- Both hands counting, all right hand passes are doubles
- A starts with 4 clubs
- A and E start with right hand
- B, C and D start with left hand

The steady state right hand sequence is feed 3 passes, double self, then the sequence self, pass, double self, self two times. Repeat.

Pattern by Luke Emery, 1999.

Extra Clubs Feast

The feast is an extension to the 5 juggler feast and the 5 juggler Extra Club Rotating Feed. The feeders alternate straight across right hand triples and doubles to keep the timing working.

Juggler	1	2	3	4	5
A	Pause		D-E		T-C
B		T-D	Pause		D-A
C		D-B		T-E	Pause
D	T-A	Pause		D-C	
E	D-D		T-B	Pause	

- Both hands counting, all right hands are double or triple passes
- D and E start with 4 clubs and right hands
- On the very start only, A skips the pause and starts with a D-C on 1 with right hand
- B and C start with left hand

Wow. Remember, if it were easy, then anyone could do it...

If that is just too crazy, then you can do the same pattern idea slower.

Juggler/beat	1	2	3	4	5	6	7	8	9	10
A	D-C		D-C		D-D		D-E		D-E	
B		D-self	Pause		D-C		D-D		D-D	
C		D-A		D-B		D-B		D-self	Pause	
D		D-E		D-A		D-A		D-B		D-C
E	D-D		D-D		D-self	Pause		D-A		D-B
Juggler/beat	11	12	13	14	15					
A	D-self	Pause		D-B						
B	D-E		D-A		D-A					
C	D-D		D-E		D-E					
D		D-C		D-self	Pause					
E		D-B		D-C						

- Both hands counting, all right hands are double passes or double selves
- A and E start with 4 clubs and right hands
- B,C and D start with left hand

Heres another related pattern that might be easier than the first.

Juggler/beat	1	2	3	4	5
A		T-D	Pause		D-D
B		D-E		T-E	Pause
C	T-A	Pause		D-A	
D	D-B		T-B	Pause	
E	Pause		D-C		T-C

- Both hands counting, all right hands are double or triple passes
- D and C start with 4 clubs and right hands
- On the very start only, E does a pause on 1 and then a left self on 2
- A and B start with left hand

Patterns by Luke Emery, 1999.

There are lots of patterns involving 5 jugglers equally spaced around a circle, and where the passing lines form an iconic 5-pointed star.

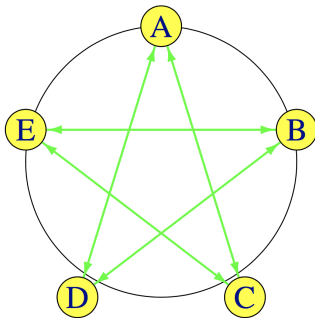

Basic Star

Juggler/beat	R	L
A	D	C
B	E	D
C	A	E
D	B	A
E	C	B

- The passing table indicates an odd count, so that right passes go to the right side and lefts go to the left side
- If an even count (right-handed), then only pass to the person 2 spots around to your right.

This is for 5 jugglers what a box is for 4 jugglers. The passes are synchronous, so there's collision potential unless people are well timed.

Classic pattern.

Selfless Star

Juggler/beat	1	2	3	4
A	B	C	D	E
B	C	D	E	A
C	D	E	A	B
D	E	A	B	C
E	A	B	C	D

- 3-count

You can extend this pattern to 2 of 3-count or even 1-count if you're feeling ambitious (rights and lefts always go to opposite sides). Good luck with that.

When was this pattern created? We have been doing it since 1992.

Feast-Star

This is a fun brain game. You alternate passes of a star and of a feast!!

Extra-Club Stars

There are lots of nice variations on a star with extra clubs. If you're comfortable with 7 and 8 club passing patterns using left and right passes, try these.

4-Count Extra Club Star

In this straight forward variation, each juggler passes in a 4-count across and to the right. This pattern has only right hand passes and right to left double selves.

Juggler/beat	1	2	3	4	5
A	D-D		D-self	Pause	

Juggler/beat	1	2	3	4	5
B	Pause		D-E		D-self
C		D-self	Pause		D-A
D		D-B		D-self	Pause
E	D-self	Pause		D-C	

- Both hands counting
- A starts with 4
- A, E start with right
- B, C, D start with left (B starts with a Pause, so B actually starts with a right on beat 2)

5-Count Extra Club Star

This is an extension of the 3-count extra club triangle. Each juggler passes doubles in 5 count across and to the right. All passes cross (rights to right, lefts to left).

Juggler/beat	1	2	3	4	5
A	D-D				
B			D-E		
C					D-A
D		D-B			
E				D-C	

- Both hands counting
- A starts with 4

All jugglers start with right hand

PSPSS Star

We can continue to add clubs and passes to the 5-Count star, until it is a 1-Count star with 20 clubs and all throws are crossing double passes. However, that is really hard.

Here's a nice variation that is challenging but very doable and looks great. The key to this pattern is precise timing. There are two doubles crossing the circle on every beat and the timing must be exact so they don't collide. If there is any variation, throw the first pass a little late and the second pass a little fast.

Juggler/beat	1	2	3	4	5
A	D-D		D-D		
B			D-E		D-E
C		D-A			D-A
D		D-B		D-B	
E	D-C			D-C	

- Both hands counting
- A and E starts with 4
- All jugglers start with right hand

Triply Star

In this star a triple pass goes around the pattern. Single passes take up the extra time.

Juggler/beat	1	2	3	4	5
A	T-D			C	D
B	D	E	T-E		
C			E	A	T-A
D	B	T-B			A
E		B	C	T-C	

- Right-hand counting
- A starts with 4

If you want to get crazy, note that each juggler has 2 right selves in a row. That's exactly enough time for each juggler to do a triple self with a pirouette and stay in time.

If you need to mellow it out, you can remove all the single passes and just pass a triple around in 10-count.

Here's another variation with triple selves instead of triple passes.

Juggler/beat	1	2	3	4	5
A	T-self	D		C	D
B	D	E	T-self	E	
C	A		E	A	T-self
D	B	T-self	B		A
E		B	C	T-self	C

- Right-hand counting
- C starts with 4

There could be many more interesting star variations based on siteswaps that are passed from one star point to the next. I've seen a few demonstrated at European conventions.

Pattern by Luke Emery.

20 Club Star

This classic pattern is just a star where every juggler starts with 4 clubs and does 2-count doubles to the juggler across and to the right.

It's a good study in timing.

Twirly Star

Here's a fun variation on the Shooting Star (4-person pattern), but with 5 people and less moving.

Juggler/beat	1	2	3	4	5
A	D	D	Pirouette	D	D
B	E	E	E	E	Pirouette

Juggler/beat	1	2	3	4	5
C	A	Pirouette	A	A	A
D	B	B	B	Pirouette	B
E	Pirouette	C	C	C	C

- Right-hand counting, 2-count
- E starts with 2 clubs

Make sure to keep the count after the pirouette! (At first you can just pause for 2 counts instead of pirouetting.) You'll pirouette holding 2 clubs.

Pattern by Luke Emery.

Up-Up-Over-5

Refer to Up-Up-Over for 3 jugglers; recall this one involves simultaneous double throws from both hands. Expand from 2 facing 1 to 3 facing 2 jugglers. Now only the outside jugglers on the line do Up-Up-Over; the other three are Over-only feeders. Remember, these are simultaneous (right and left) double throws.

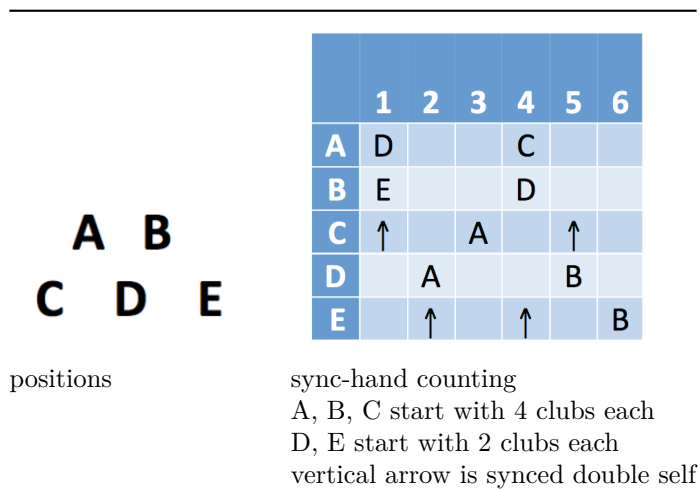

Gauntlet

This is an easy but need-to-pay-attention moving pattern, which the Cool Guyz used once to exit the Madfest stage. It's a 5-person 4-count. On each passing beat one juggler (yellow nodes in figure) has 2 clubs (and doesn't pass). These occur twice in a row for each juggler, as he/she moves through the middle and waits to receive a pass at the *bottom* of the pattern. The leader calls out *down, box, down, box* on passing beats, and the passes and movements are as in the figure..

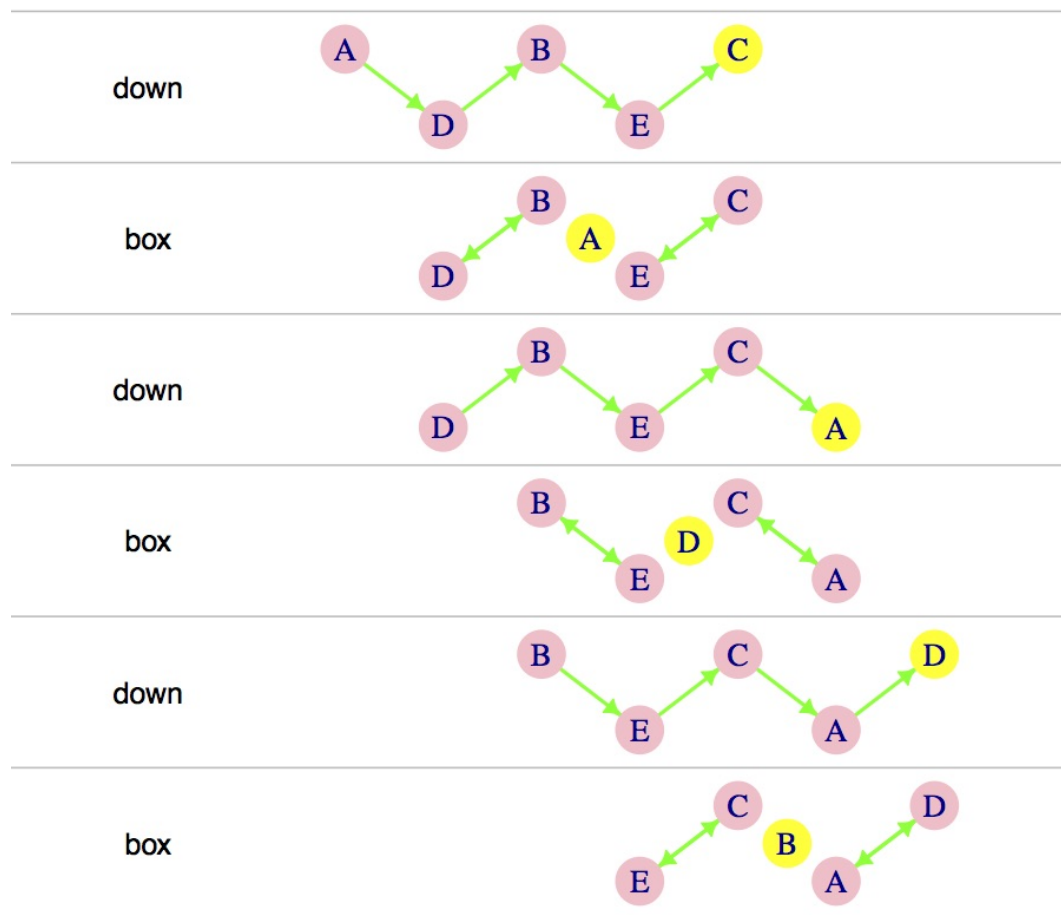

...continue...

Mr. Inside-Mr. Outside Weave

This modifies the standard weave by dividing the feeder into two feeders (one passing on the inside and one on the outside), both on 4-count in the standard version. It's a good warm up pattern for the Twister Weave (see below).

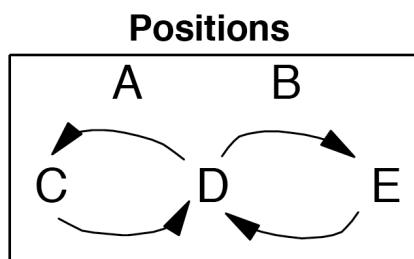

positions

Juggler/beat	1	2	3	4	5	6
A	C		E		D	
B		D		C		E
C	A			B		
D		B			A	
E			A			B

Right-hand counting

Juggler A is also called Glen Davis (Mr. Outside), and Juggler B is Doc Blanchard (Mr. Inside), for reasons that none of us recall, though Tom Pomraning insisted on the names. Movements of the weavers are identical to the Standard Weave, though passes go alternatively to the two feeders.

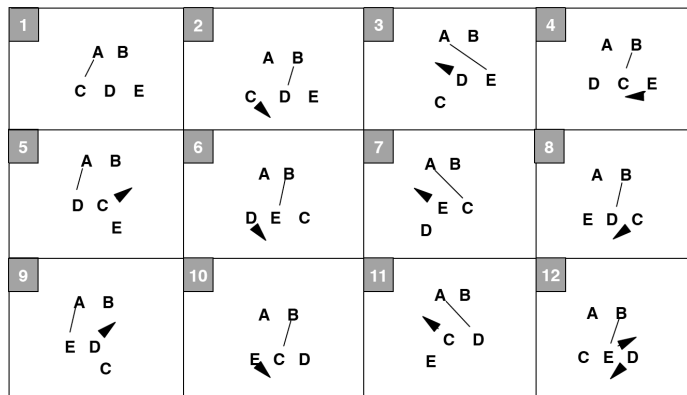

The same variations for the standard weave and the Twister Weave can be used for this pattern, but there are some others. For example, Jugglers A and B can set up on a line perpendicular to the weave, with A (outside) further from the weave. We have been doing it since at least 1994, but are not sure of its origin. It must predate the MAJ; the Mad-5 performed it at the 1996 Madfest.

Twister Weaves

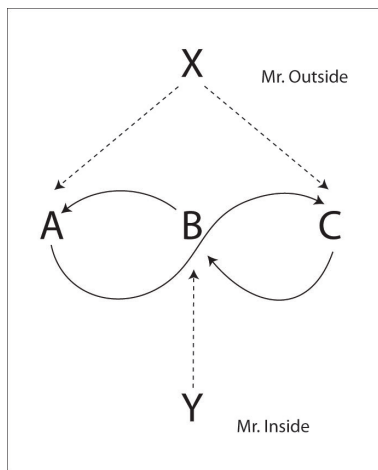

The original Twister Weave is perhaps one of our greatest discoveries. It has the exact same passing table as the Mr. Inside Mr. Outside Weave. However, Mr. Inside and Mr. Outside are on opposite sides of the weavers, so the feedees turn around after every pass. When we first tried this on Library Mall in the late 90's it seemed incredibly hard, probably because we hadn't yet mastered moving patterns involving rotations; Oogle Boogies and other weaves had moves but no rotations; Egg Beaters had 90 degree rotations; Quincunx had a full rotation but it was very slow. Good self throws make the difference!

Original Twister Weave

Count: Feeders 4-Count, Feedees 6-Count moving.

Each weaver passes once on the end to Mr. Outside (X), and then has a 6-count (2 right hand selves) to move to the inside and turn around. Then pass once to Mr. Inside (Y) and continue in a 6-count outside and then turning around.

The turns may be done by turning towards the inside or towards the outside. Most people find inside turns easier in the middle and on the ends (i.e. back away from the current feeder and then turn towards the new feeder). However, we suggest that you learn both turns and see which combinations you like best.

Juggler/beat	1	2	3	4	5	6	7	8	9	10	11	12
X	A				C				B			
Y			B				A				C	
A	X						Y					
B			Y						X			
C					X						Y	

- Both hands counting, all passes right hands
- Animation².

Here are some other twister weaves with the feeders in different counts. They get progressively trickier, so get ready!

PSPSP Twister Weave

Count: (Feeders share PSPSP, Feedees 5-count moving)

Juggler/beat	1	2	3	4	5	6	7	8	9	10
X	A				C			B		
Y			B			A				C
A	X					Y				
B			Y					X		
C					X					Y

- Both hands counting

3-Count Twister Weave

Count: Feeders 3-count, Feedees alternate 5-count, 4-count, moving

For unbalanced weaves (where the weaver does a different count going inside-out than outside-in) it generally seems easier to do the more challenging count (the smaller one) on the outsides.

Juggler/beat	1	2	3	4	5	6	7	8	9
X	A			C			B		
Y			B			A			C
A	X					Y			
B			Y				X		
C				X					Y

- Both hands counting

²<http://juggloid.com/editor/?s=sU0PC0>

Fast Twister Weave

Count: Feeders 3 of 8, Feedees 4-count, moving

Juggler/beat	1	2	3	4	5	6	7	8
X	A		C		B			
Y	B				A		C	
A	X				Y			
B	Y				X			
C			X				Y	

- Both hands counting

Ultra-Twister Weave

Count: Feeders 3 of 7, Feedees alternate 4-count, 3-count, moving

Juggler/beat	1	2	3	4	5	6	7
X	A			B		C	
Y	B		C		A		
A	X				Y		
B	Y			X			
C			Y			X	

- Both hands counting

Hyper-Twister Weave

Count: Feeders 2-count, Feedees 3-count, moving

This is a master-class pattern, owing to 180 degree turns after every pass and on 3-count. Good leads are essential!

Juggler/beat	1	2	3	4	5	6
X	A		C		B	
Y		B		A		C
A	X			Y		
B		Y			X	
C			X			Y

- Both hands counting

There are lots of variations on the Twister Weave. See the Twister Plus, Double Time Twister, etc.

We can add 2 clubs to the standard Twister Weave and make the passes from X and Y to the weavers be triples (7 club 4-count between each side of the weave and the feeder), and the return passes triples too.

Another variation is to add 2 extra clubs and have the feeders do 4-count in fast popcorn (534p3).

Try the twister weave in chocolate bar too.

Original Twister Weave suggested by Mike Newton. Variations by MAJ.

Twister Plus

In this beautiful variation of the Twister Weave the feeders replace their right-hand selves with triple passes back and forth over the top of the weave, in 7-club 4-count style. The weaving pattern is exactly the same as the Original Twister Weave.

Juggler/beat	1	2	3	4	5	6
X	A	T-Y	C	T-Y	B	T-Y
Y	T-X	B	T-X	A	T-X	C
A	X			Y		
B		Y			X	
C			X			Y

- Right-hand counting
- Y starts with 4

Another nice variation is for the weavers to do $\frac{1}{2}$ pirouettes under a triple right to left self throw for their turn.

Also see Twister++ and Twister 5.

Pattern by MAJ.

Double Time Twister

The Double-time Twister is the same as the Twister Weave with each weaver passing twice to each feeder before turning around to pass twice to the other feeder. Now each feeder is passing 2-count: passing twice to each weaver as they go by.

Juggler/beat	1	2	3	4	5	6
X	A	A	C	C	B	B
Y	C	B	B	A	A	C
A	X	X		Y	Y	
B		Y	Y		X	
C	Y		X	X		Y

- Right-hand counting

For each weaver that A passes to, the first pass is made when the weaver is on the outside. The weaver moves to the inside, following the arrows, for the second pass. A is Mr. Outside In.

For each weaver that B passes to, the first pass is made when the weaver is in the inside. Then the weaver moves to the outside, following the arrows, for the second pass. B is Mr. Inside Out.

To see what the weavers do, let's look at what A does. A passes to X in the outside position and then moves to the inside where the next pass is made to Y. A has one right hand self throw to turn around and make the first throw to Y. The first pass to Y is made when A is on the inside. A then moves to the outside to make the second pass to Y and has one self throw to turn around and repeat the pattern.

All weavers do the same thing two passes out of phase.

Pattern created by MAJ.

Double Time Twister Plus

Here is a twister variation with 2 extra clubs where the passes to and from the weave are all doubles like an extra club feed.

Juggler/beat	1	2	3	4	5	6	7	8	9	10	11	12
X		D-A		D-C		D-C		D-B		D-B		D-A
Y		D-B		D-B		D-A		D-A		D-C		D-C
A	D-X		D-X				D-Y		D-Y			
B			D-Y		D-Y				D-X		D-X	
C	D-Y				D-X		D-X				D-Y	

- Both hands counting
- A and C start with 4
- A, B and C start with right hand
- X and Y start with left hand

Pattern by Luke Emery and MAJ.

Twister Popcorn

The Twister Popcorn is the same as the Popcorn Feed except there are 2 feeders, one on each side, and each popcorn feedee passes to one, turns to pass to the other, and repeats. The feedees do not weave in this pattern. That's the next pattern. In this pattern they just turn in place. The feeders do a Typewriter Feed.

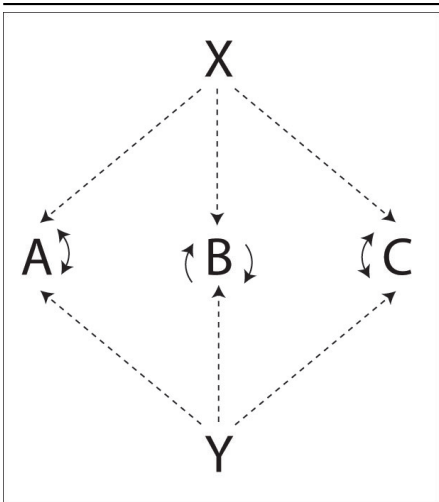

positions

Juggler/beat	1	2	3	4	5	6
X	D-A		D-C		D-B	
Y		D-B		D-A		D-C
A	T-self	D-X		T-self	D-Y	
B		T-self	D-Y		T-self	D-X
C	D-Y		T-self	D-		T-self

Right-hand counting

The hardest position is the middle feedee, because he/she cannot cheat as much into the turns. You can either turn fast during the single self, throw a right to left single straight up in the air and do a $\frac{1}{2}$ pirouette underneath it, or throw a behind the back self to turn.

- X and C start with 4

- A, B and C are 1 beat after X and Y

It's probably best to be quite comfortable with popcorn feeds before spending a lot of time on this pattern. Pattern by Luke Emery and MAJ.

Twister Popcorn Weave

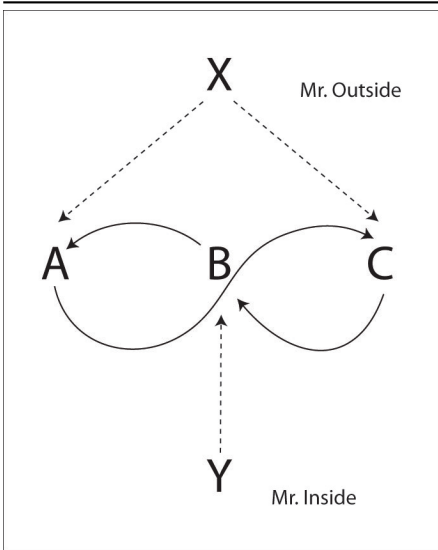

Juggler/beat	1	2	3	4	5	6
X	D-A		D-C		D-B	
Y		D-B		D-A		D-C
A	T-self	D-X		T-self	D-Y	
B		T-self	D-Y		T-self	D-X
C	D-Y		T-self	D-X		T-self

positions

Right-hand counting

- and C start with 4
- A, B and C are 1 beat after X and Y

Pattern by Luke Emery.

Four-Leaf Clover

So the deal with clover patterns is that the number of jugglers is one more than the number of leaves; there's always one juggler on each leaf and one extra in the middle, about to swap places with one of the leaves. This is a very pleasant 5 person moving pattern; all jugglers do the same thing in the steady state: feed three (right to left); 2-selves to move into middle; pass in middle; 4 selves to get out. That's a *2-in-4-out*, in contrast to the *2-in-2-out* three-leaf clover for four jugglers. Each juggler's job repeats after 10, but the whole pattern takes 40 rights to complete.

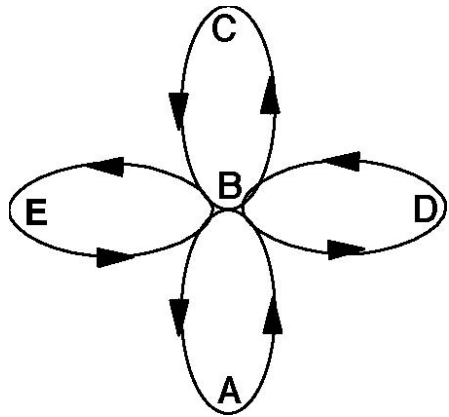

Juggler/beat	1	2	3	4	5	6	7	8	9	10
A			D	C	B			E	*	
B	*				A	D	E			C
C		D		A	*				E	B
D		C	E	A		B	*			
E			D	*			B	A	C	

positions

Right-hand counting

“*” notes when jugglers are in the center

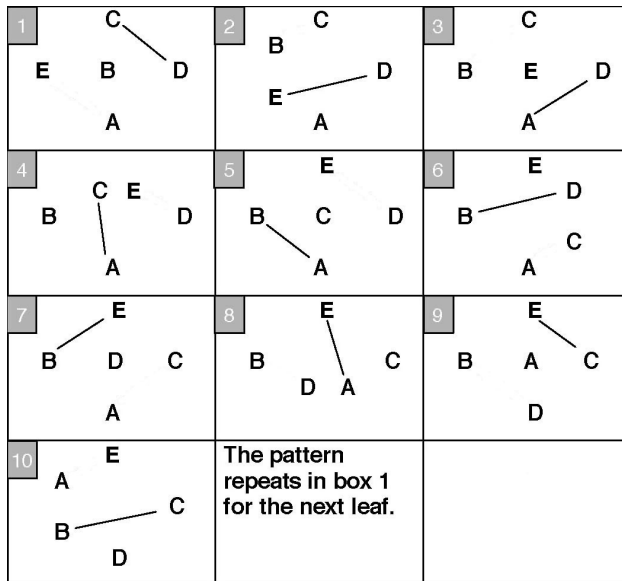

Variations:

It's fun to try different counts, such as on a 3-count base instead of a 2-count base.

See all of those self throws? Well, you can fill some of them in by adding another pass on every beat.

Juggler/beat	1	2	3	4	5	6	7	8	9	10
A	E		D	C	B	C	C	E	*	E
B	*	C	C		A	D	E	D	D	C
C	D	B	B	A	*	A	A		E	B
D	C	E	A	E	E	B	*	B	B	
E	A	D	*	D	D		B	A	C	A

- Right-hand counting

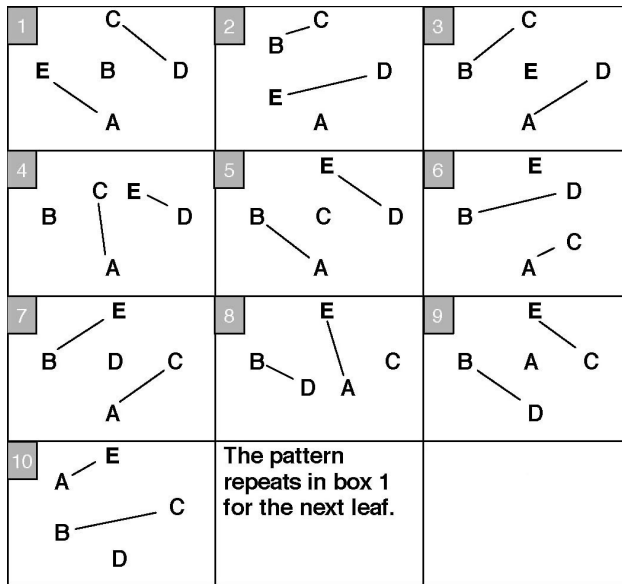

Patterns by MAJ.

Chocolate Swirl

The chocolate swirl is a moving extension of Double Chocolate Double Three Count. It is noteworthy for jugglers moving from one side of the pattern to the other with only a single self throw. That is possible. It is also noteworthy for being hard, both to remember and to juggle. The table shows a single transition where E moves to the other side.

<p>A B C D E</p>	<table border="1"> <thead> <tr> <th>Juggler/beat</th> <th>1</th> <th>2</th> <th>3</th> <th>4</th> <th>5</th> <th>6</th> <th>7</th> <th>8</th> <th>9</th> <th>10</th> <th>11</th> <th>12</th> </tr> </thead> <tbody> <tr> <td>A</td> <td>C</td> <td>C</td> <td>D</td> <td>C</td> <td>C</td> <td></td> <td>C</td> <td>C</td> <td></td> <td>C</td> <td>C</td> <td></td> </tr> <tr> <td>B</td> <td>E</td> <td>D</td> <td>E</td> <td>E</td> <td>D</td> <td>C</td> <td>D</td> <td></td> <td>C</td> <td>D</td> <td></td> <td>C</td> </tr> <tr> <td>C</td> <td>A</td> <td>A</td> <td></td> <td>A</td> <td>A</td> <td>B</td> <td>A</td> <td>A</td> <td>B</td> <td>A</td> <td>A</td> <td>B</td> </tr> <tr> <td>D</td> <td></td> <td>B</td> <td>A</td> <td>B</td> <td>B</td> <td>E</td> <td>B</td> <td>E</td> <td>E</td> <td>B</td> <td>E</td> <td>E</td> </tr> <tr> <td>E</td> <td>B</td> <td></td> <td>B</td> <td>B</td> <td>Move</td> <td>D</td> <td></td> <td>D</td> <td>D</td> <td></td> <td>D</td> <td>D</td> </tr> </tbody> </table>	Juggler/beat	1	2	3	4	5	6	7	8	9	10	11	12	A	C	C	D	C	C		C	C		C	C		B	E	D	E	E	D	C	D		C	D		C	C	A	A		A	A	B	A	A	B	A	A	B	D		B	A	B	B	E	B	E	E	B	E	E	E	B		B	B	Move	D		D	D		D	D
Juggler/beat	1	2	3	4	5	6	7	8	9	10	11	12																																																																			
A	C	C	D	C	C		C	C		C	C																																																																				
B	E	D	E	E	D	C	D		C	D		C																																																																			
C	A	A		A	A	B	A	A	B	A	A	B																																																																			
D		B	A	B	B	E	B	E	E	B	E	E																																																																			
E	B		B	B	Move	D		D	D		D	D																																																																			

positions Right-hand counting
Right hand starts

Once you get comfortable with one transition at a time, then you can run the transitions faster. Or so we imagine... we've never been that comfortable!

Pattern by Luke Emery

Mango Swirl/Mangled Squirrel

- 5 jugglers: all good with 7-club 2-count passing and moving
- Positions: 2 facing 3, as above in Chocolate Swirl
- Continuously, juggler on end of 3-line switches sides creating flipped 2-facing-3

The Mango Swirl was an attempt to create a change sides pattern for the 2 extra club W pattern. Unfortunately, our first attempts were more mangled than mango, and more squirrely than swirly and thus its alternate name. There are a couple possible transitions. Although we originally created the pattern with a different transition, this one seems easier (especially if you've practiced the Extra Club Turbo).

Juggler/beat	1	2	3	4	5	6	7	8	9	10	11	12
A	D-D		D-C		D-C	Move			T-B	Pause		D-E
B	(D-E)		D-D		D-D		D-C		D-A		D-A	Move
C			T-A	Pause		D-B		D-B		D-E		D-D
D		D-A		D-B		D-E		D-E	Move			T-C
E		D-B	Move			T-D	Pause		D-C		D-C	
Juggler/beat	13	14	15									
A		D-E										
B			T-E									
C		D-D	Move									
D	Pause		D-A									
E	D-A		D-B									

- Both hands counting, right hand passes
- A and B start with 4, right hands
- C starts with 3, right hand
- C, D and E start with 3, left hands

In steady state, B is on a pause for beat 1, but throws D-E at the very start.

In steady state, C moves on beat 1, but is in initial position for beat 1 at the very start.

E moves first by turning around and passing a triple to D. A moves second by moving to the opposite side and throwing a triple to B, and so on.

The rhythm is: move, triple pass, 2 doubles to one, 1 double to the next, 2 doubles to the next. And repeat. Remember: *Triple-2-1-2*.

Yeah, it's kind of tricky. You can also add two more jugglers, one to each end, to get *Triple-2-1-2-1-2!*

Pattern by Luke Emery

Egg Beaters

Original Egg Beater

This one has one feeder and 4 movers – in 2 pairs of 2 spinning around each other. A is the *handle*, B and C are one *beater*, and D and E are the other *beater*. It's pretty good for beginner movers on this original base count, but you have to think because your count changes as you go: 6-count; 4-count; 6-count. Performed by Mad-5 at 1997 Madfest.

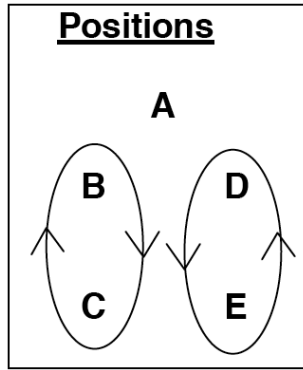

Juggler/beat	1	2	3	4	5	6	7	8
A		E		B		D		C
B		D		A			E	
C			D		E			A
D		B	C			A		
E			A		C		B	

positions

Right-hand counting

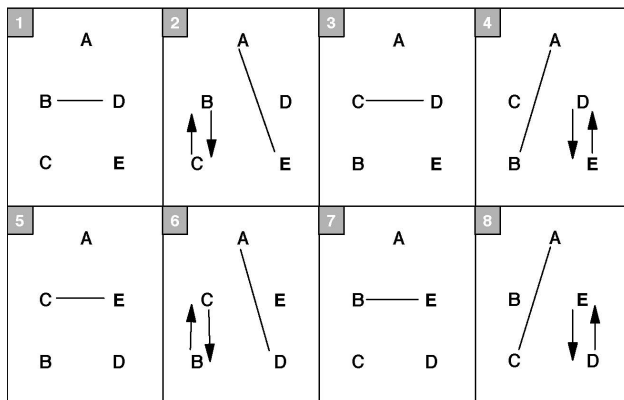

Variations: Add a club (Luke's Egg Beater Plus), speed it up (3-4-5 Egg Beater), move the handle, change the passes, etc.

Martin Frost's Variation

Juggler/beat	1	2	3	4	5	6	7	8
A		E		B		D		C
B		D	E	A	D		E	
C		E	D		E		D	A
D		B	C		B	A	C	
E		C	A	B	C		B	

- Right-hand counting

Born at 1996 Madfest.

Luke's Egg Beater Plus

Change the long passes to and from the feeder to triples to get this impressive looking pattern.

Juggler/beat	1	2	3	4	5	6	7	8
A	T-E		T-B		T-D		T-C	

Juggler/beat	1	2	3	4	5	6	7	8
B	D		E	T-A	D		E	
C	E		D		E		D	T-A
D	B		C		B	T-A	C	
E	C	T-A	B		C		B	

- Right-hand counting
- A starts with 4

3-4-5 Egg Beater

As your passing skills develop the original Egg-Beater gets a little boring. The 3-4-5 variation has the same trajectory and the same sequence of folks you pass to, but it's accelerated, and it uses both hands. This one has 12 total 1-count beats, where the original egg-beater has 8 2-count (i.e. 16 1-count) beats. Specifically, the feeder does 3-count and the egg-beaters progress through 3-count, 4-count, then 5-count.

Juggler/beat	1	2	3	4	5	6	7	8	9	10	11	12
A		E		B			D				C	
B	D				A					E		
C				D			E				A	
D	B			C				A				
E		A					C			B		

- Both hands counting

Since the feeder's doing 3-count, this pattern is mates with anything needing a 3-count position, such as a 4-5 Twister. Estimated birth, 2016.

Egg Beater, Handle in the Batter

This variation moves the feeder to the other side of the pattern.

Positions

Juggler/beat	1	2	3	4	5	6	7	8
A		C		D		C		D E
B	D			C	E	D		C
C		A	E	B		A		B
D	B			A		B	E	A
E			C		B		D	A

positions
Right-hand counting

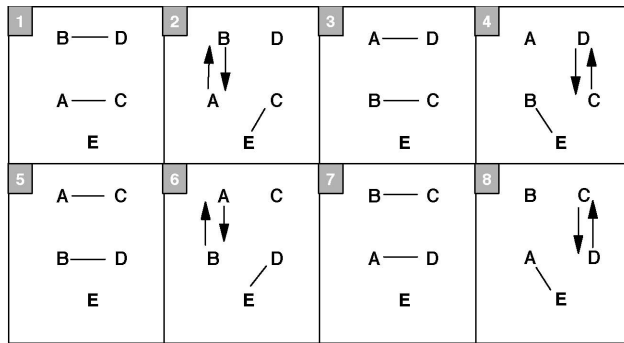

Pattern by Mike Newton and MAJ.

Egg Beater, Switching Handles

This pattern is a cool way to get the handle into the action, continuously. It was first done Nov 2, 17 (long after the original egg-beater) by Graham=A, Mel=B, Mike=C, Jeff=D, Nick=E; nickname EggBeatOff). The table shows positions where each juggler (column) must be at that passing beat [right-hand counting in rows]. Only passes are indicated. So positions 1-2 exchange, similarly 3-8, 4-7, and 5-6. The upper graph shows where each juggler moves; edge weights indicate number of right-hand counts up to next throw. Lower graph shows passing events. Start with jugglers at 4, 7, near 1, 2, and on the edge moving towards 6. There are 30 right hand beats to get around, which seems excessive but doesn't feel so bad when juggling, thanks to symmetries I guess.

Beat/Juggler					
	A	B	C	D	E
1		7			4
2	2		1		
3					
4	3	8			
5				6	5
6					
7	4			7	
8		1	2		
9					
10			3	8	
11	5				6
12					
13			4		7
14		2		1	
15					
16		3			8
17	6		5		
18					
19	7	4			
20				2	1
21					
22	8			3	
23		5	6		
24					
25			7	4	
26	1				2
27					
28			8		3
29		6		5	
30					

Positions/movements

Start: A near 2; B at 4; C near 1;
D moving towards 6; E at 7

Table entries show position of receiver of pass from juggler (column)

Passes

Strange Attractor / Estranged Tractors

This came from trying to fill in the self gaps of a Turbo using two stationary jugglers.

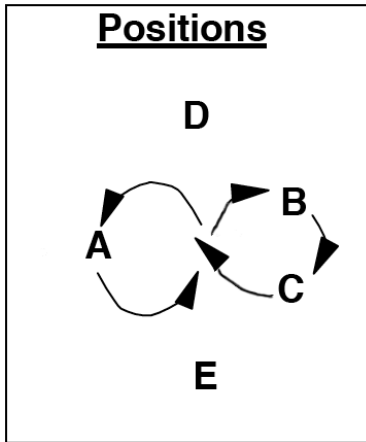

Juggler/beat	1	2	3	4	5	6	7	8	9
A	B	C	E	E	B		C	D	D
B	A	D	D	C	A	E	E	C	
C	E	A		B	D	D	A	B	E
D		B	B		C	C		A	A
E	C		A	A		B	B		C

positions

- Right-hand counting
- A, B, and C are moving in a figure eight as in a Turbo or a 2-leaf Clover pattern. D and E are feeders.

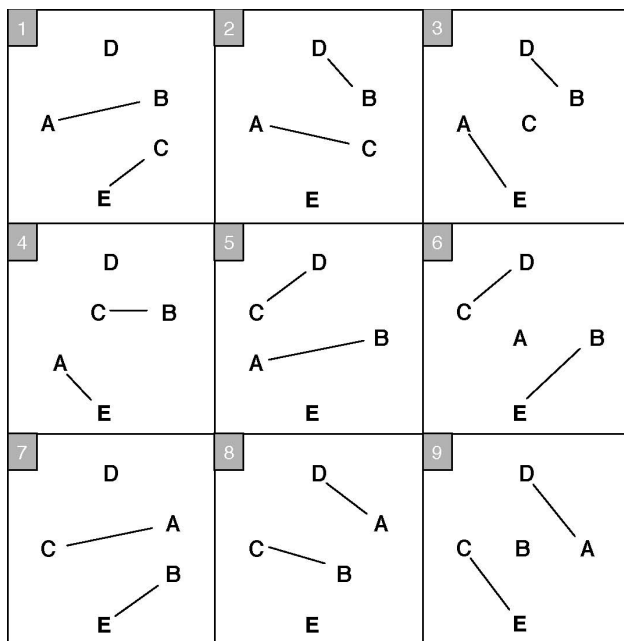

Pattern created by MAJ.

Whirling Melvish

Consider a 14 club box in 4-count. There's room in the middle for one or two jugglers. If they pass with each of the corners while turning slowly in a circle, that's the Whirling Melvish.

To make it easier, the Melvish (the juggler in the middle, who may or may not be named Melonhead), can do 2 passes in a row to each corner.

Juggler/beat	1	2	3	4	5	6	7	8	9	10	11	12	13	14	15
A	T-C		M		T-C		M		T-C				T-C		
B		T-D				T-D				T-D		M		T-D	
C			T-A				T-A				T-A				T-A
D				T-B				T-B				T-B			
M		D-B	Pause				A				D-B	Pause			

- Both hands counting
- A and B start with 4 clubs
- A, C and M start with right hand
- B and D start on 2 with right hands

A single transition takes from beat 1 through beat 9. At 10 it starts over with the next corner.

The Melvish passes a straight double, pauses and then does a normal 4-count pass to one corner (A in this case), then turns and throws an early straight double in 4-count to the next corner. Wait for 1 beat, then resume the 4-count. Moving after every 2 passes (1 double and 1 single) is a nice timing.

You can add an additional Whirling Melvish juggler in the middle back to back to the original mover. That juggler starts in a 4-count with C and does the same thing as M, 2 beats later.

Pattern by Luke Emery, 2000.

Cathedral

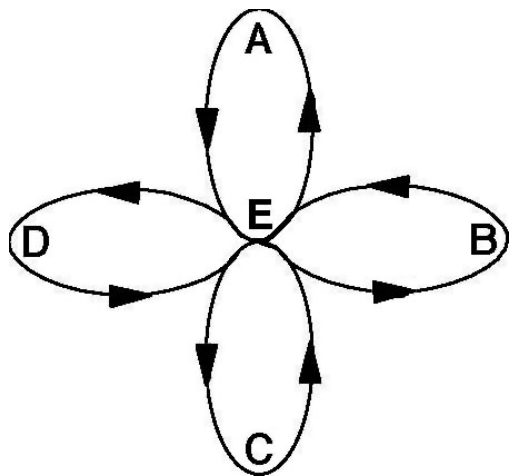

The Cathedral is an extension of the GDP to 5 jugglers. It is a 4 leaf clover with 2 extra clubs and all triple passes over the top. This is a spectacular pattern, but challenging.

The outer box maintains a 14 club box in 4-count triples.

The center juggler passes once with a leaf and then replaces that leaf in a 6-count turn. The table below shows one transition, where E replaces A, and A completes the transition facing B.

Juggler/beat	1	2	3	4	5	6	7	8	9	10	11	12	13	14	15
A	T-C		E		T-C						D-B	Pause			
B		T-D				T-D				T-D		A		T-D	
C			T-A				T-A				T-E				T-E
D				T-B				T-B				T-B			
E		D-A	Pause						T-C				T-C		

- Both hands counting
- Beats 1 through 9 make up a single transition.

Pattern by Luke Emery, 2000.

Quincunx

Ahhh... Quincunx. We don't actually juggle this pattern much anymore. We just talk about it. Whenever we can't think of a pattern to try, someone inevitably says, "Let's do Quincunx!" Then we all laugh. Ha, ha! Ok, seriously. What should we do?

With no disrespect for Mike intended, this is kind of a dumb pattern. It's complicated and almost impossible to remember for a full cycle. I haven't done this pattern in at least 8 years, and I don't think anyone else in the MAJ has either. (Melonhead says he still likes it...)

Now that it's a part of the MAJ mythology though, we can't take it out of the pattern book. Maybe you should try it for yourself and see what you think!

Juggler/beat	1	2	3	4	5	6	7	8	9	10	11	12	13	14	15	16	17	18	19	20
A	E	C	C			D	D	B	B	C		B	B	D	C	E	E		D	E
B	D	E		D	D	C	E	A	A		C	A	A	E	E			C	C	D
C		A	A	E	E	B		E	E	A	B	D	D		A	D	D	B	B	
D	B		E	B	B	A	A			E	E	C	C	A		C	C	E	A	B
E	A	B	D	C	C		B	C	C	D	D			B	B	A	A	D		A

- Right-handed 4-count
- Lines indicate passes; arrows indicate movement.

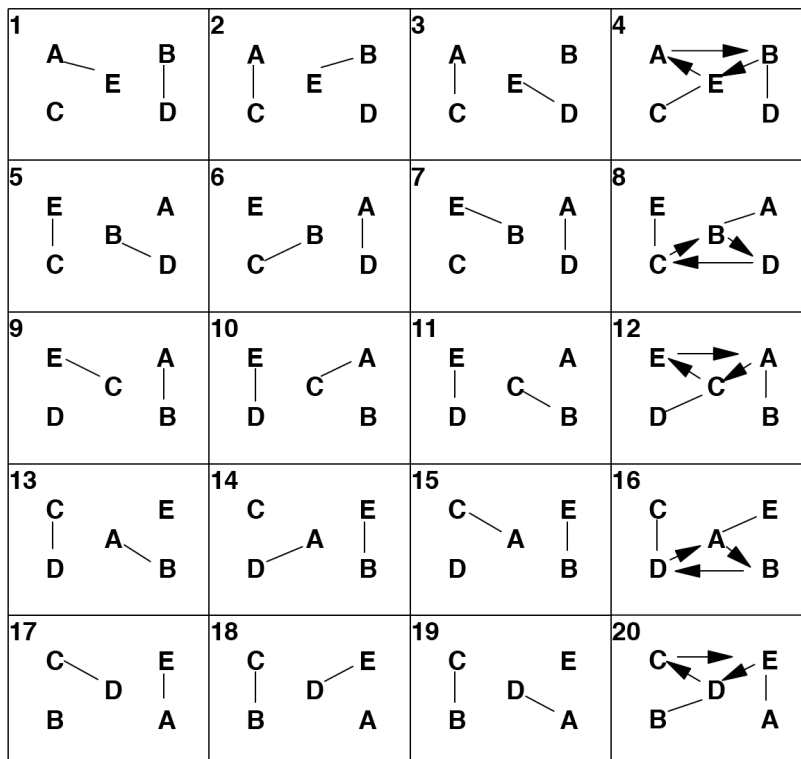

Pattern by Mike Newton.

Ivy- π weave (read ivy pi weave)

Here's a variation on the $2\pi/3$. We figured it out by adding one and then a second feeder to fill the gap in the 3-person pattern. Then we noticed you could have everyone move through all the positions. Pretty fun. First tried Aug 27, 2017 by Mike, Mel, Conor, Nick, and Jason. We do this on a 4-count base, which keeps the moves doable. So, e.g., each juggler passes 4 in a row on that count, and then has a break. But each juggler only passes to 2 other jugglers. Note the sharp turns going from positions 2-to-3 and 7-to-8.

positions						passes						Moves
	A	B	C	D	E		A	B	C	D	E	
1	1	3	5	7	9	1	D	E		A	B	
2	2	4	6	8	10	2	C	D	A	B		
3	3	5	7	9	1	3	D		E	A	C	
4	4	6	8	10	2	4	C	E	A		B	
5	5	7	9	1	3	5		D	E	B	C	
6	6	8	10	2	4	6	D	E		A	B	
7	7	9	1	3	5	7	C	D	A	B		
8	8	10	2	4	6	8	D		E	A	C	
9	9	1	3	5	7	9	C	E	A		B	
10	10	2	4	6	8	10		D	E	B	C	
												Passes

El Turbo plus one post

Refer back to 4-person El Turbo. In variations see on adding one or two 4-count stationary posts.

Chapter 6

6 Person Patterns

1-2-3 Apollo

This Apollo for 6 jugglers is another Madison classic. (There are Apollos for all numbers.)

A	B C	D E F
positions		
	Right-hand counting	

Juggler/beat	1	2	3
A	D	F	
B	E	D	
C	F	E	
D	A	B	
E	B	C	
F	C	A	

Nice easy 4-count pattern.

Pattern by MAJ.

Feast

Everyone feeds everyone else.

Variation: When on 3-count, try to **Picnic**. I.e., do one cycle on straight throws and the next on crossing throws. This creates some crazy Jim's jams.

Argyles

Argyled Triangles

Want to challenge your left-right passing? Try one of these.

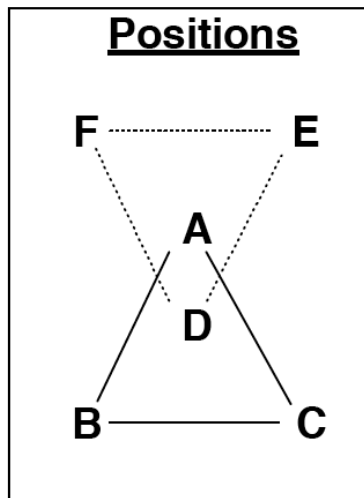

positions

Juggler/beat	1	2	3	4	5	6
A	B	D		C	D	
B	C			A		
C	A			B		
D		A	E		A	F
E			F			D
F			D			E

both-hands counting

A and D face each other, passing double 3-count with the rest. B,C, E, and F pass 3-count.

It's trickier than you might think, even if you rock double-3 count. Helps if A and D make loopy passes to each other.

Pattern by MAJ.

Argyle Sock

Everyone does double 3-count.

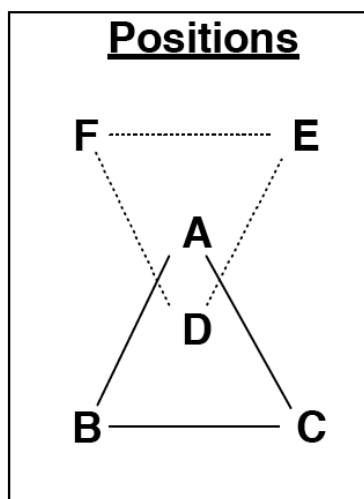

positions

Juggler/beat	1	2	3	4	5	6
A	B	D		C	D	
B	C	C		A	C	
C	A	B		B	B	
D		A	E		A	F
E		F	F			D
F		E	D		E	E

both-hands counting

See Anklet for a 4 juggler version.

Pattern by MAJ.

Hex

This is a nice 3-count warm-up for a group of six jugglers. In the steady state all jugglers do the same thing.

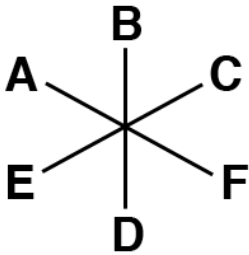
<div style="border: 1px solid black; padding: 10px; width: fit-content; margin: 0 auto;"> <p style="text-align: center; margin: 0;">Positions</p>  </div> <p style="text-align: center; margin-top: 5px;">positions</p>	<table border="1" style="border-collapse: collapse; margin: 0 auto;"> <thead> <tr> <th style="border-top: 1px solid black; border-bottom: 1px solid black;">Juggler/beat</th> <th style="border-top: 1px solid black; border-bottom: 1px solid black;">1</th> <th style="border-top: 1px solid black; border-bottom: 1px solid black;">2</th> <th style="border-top: 1px solid black; border-bottom: 1px solid black;">3</th> </tr> </thead> <tbody> <tr> <td style="border-right: 1px solid black;">A</td> <td style="text-align: center;">F</td> <td></td> <td></td> </tr> <tr> <td style="border-right: 1px solid black;">B</td> <td></td> <td style="text-align: center;">D</td> <td></td> </tr> <tr> <td style="border-right: 1px solid black;">C</td> <td></td> <td></td> <td style="text-align: center;">E</td> </tr> <tr> <td style="border-right: 1px solid black;">D</td> <td></td> <td style="text-align: center;">B</td> <td></td> </tr> <tr> <td style="border-right: 1px solid black;">E</td> <td></td> <td></td> <td style="text-align: center;">C</td> </tr> <tr> <td style="border-right: 1px solid black; border-bottom: 1px solid black;">F</td> <td style="border-bottom: 1px solid black; text-align: center;">A</td> <td style="border-bottom: 1px solid black;"></td> <td style="border-bottom: 1px solid black;"></td> </tr> </tbody> </table> <p style="text-align: center; margin-top: 5px;">both-hands counting</p>	Juggler/beat	1	2	3	A	F			B		D		C			E	D		B		E			C	F	A		
Juggler/beat	1	2	3																										
A	F																												
B		D																											
C			E																										
D		B																											
E			C																										
F	A																												

Variation 7-Club 3-count Hex. For those seeking a challenge, try a Hex where each pair juggles a 3-count 7 club pattern in doubles. It works if the passes are precise.

Pattern by MAJ.

Bubbler of David

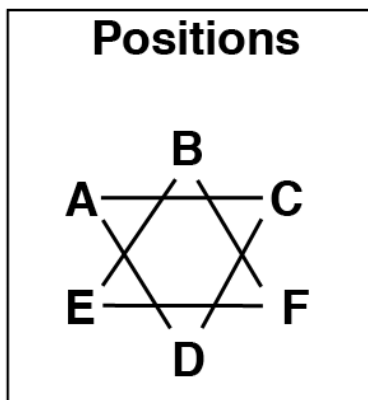

The Bubbler is a Star of David with interlocking triangles and extra clubs in 4-count doubles (that's the effervescent part).

A, C and D are in one triangle. They do a 4-count extra club triangle. The pass is a double from right hand to left hand. Each juggler passes to the juggler on their left. The timing is a little fast and syncopated (A throws to C, C throws to D 4/3 beats after A, D throws to A 4/3 beats after C).

B, F and E are another triangle. They do a 4-count extra club triangle too. F throws at exactly the same time as A, E throws with C and D is synchronized with B.

Get that pattern smooth first. Now, notice how the juggler across from you is doing a self at the exact same time as you are? Now, just pass the right hand single straight across.

As always, timing is the key.

This pattern doesn't lend itself to a table format because the counts aren't even, but it's easy to figure out. Pattern by MAJ.

6-Person Double Weaves

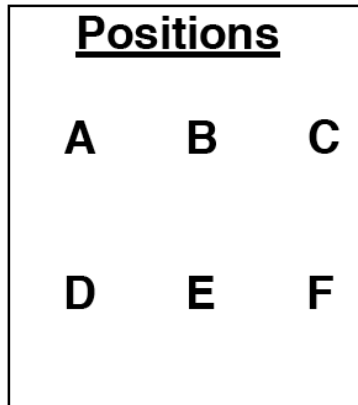

As you've seen, there are a mind boggling variety of possible weaves. Well, any of these weaves can be paired up with any other weave to make a double weave. The permutations are infinite, but here are some that we like.

Standard Double Weave

If A, B and C do a standard weave and pass across to D, E and F in a standard weave, you get the Standard Double Weave.

Juggler/beat	1	2	3
A	D		
B		E	
C			F
D	A		
E		B	
F			C

- Right-hand counting

The standard weave has each juggler moving forward in the middle, and back on the ends. Move to the next position after each pass. See the Standard Weave for more details concerning movement.

In this version jugglers pass short throws in the middle and long throws on the ends. As always, watch the lead throws!

Invert Prevert Weave (Equidistant Weave)

One team is inverted (which must mean the other team is preverted). Team DEF does an inverted weave by moving forward on the ends and backwards in the middle. This is an easier weave than the standard weave if all passers are comfortable with both standard and inverted weaves and looks nice because each juggler in a pair stays the same distance from the other.

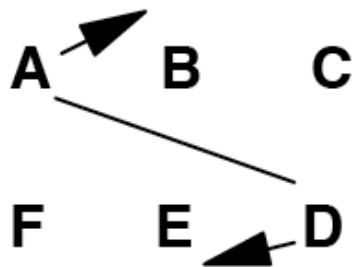

Cross-Corner Weave (Kitty-Korner Weave)

Same as the standard double weave, but pass to the opposite corner on the ends.

Extra-club Double Weave

Set up a standard double weave, but have one juggler with an extra club. Passing beat stays at 6-count; moving stays the same (figure eight), but the passes have to be doubles. Importantly, you receive from one juggler then pass to another, in order to retain the 7-club-style passing. Lead deeply on the ends and short and lofty in the middle.

Dresser Drawers Double Weave

Either, both weaves do Dresser Drawer style (see 4-person patterns), or they do that plus adding 3 clubs, as described here. Both teams do the Dresser Drawers weave. All passes are right hand doubles (like 7 2-count). Each weaver passes to only one other weaver (like in standard double weave) in a 6-count. The leads are very important.

Juggler/beat	1	2	3	4	5	6
A	D-D					
B			D-E			
C					D-F	
D		D-B				
E				D-C		
F						D-A

- Both hands counting
- A, B and C start with right hand
- D, E and F start with left hand

Switch Sides Double Weave

Switch sides at each end. For example, after A and D pass at the end, they switch positions so that A, E, and F are weaving, as are D, B, and C.

When was this pattern created? We have been doing it since 1993.

Double Gandini Weave

The Standard Gandini Weave makes a very nice double weave too. Each weaver passes twice in a row to two different jugglers, and then has 4 selves to move out, around back and into the middle. Next time move out in the opposite direction.

Juggler/beat	1	2	3	4	5	6
A				E	F	
B		D	E			
C	D					F
D	C	B				
E			B	A		
F					A	C

- Right-hand counting

For a good time, call Melonhead. Or try this pattern in chocolate bar.

Another nice variation is to add an extra club and make all the passes in the middle right hand doubles.

Based on Gandini Weaves by Gandini Juggling Project and MAJ.

Double Gandini Weave Plus

There is so much time at the back end of the Double Gandini Weave! Nine self throws! There must be something to do in all that time. Wait, I know! Let's add another club!

This is the same as the previous pattern with a triple club passed back and forth over the top of the pattern. It's a spectacular pattern and not as hard as you might think (though certainly not easy).

Juggler/beat	1	2	3	4	5	6
A		T-F		E	F	
B		D	E			T-E
C	D			T-D		F
D	C	B			T-B	
E	T-A		B	A		
F			T-C		A	C

- Right-hand counting

Pattern by Luke Emery.

Stick on the End Double Weave

Two teams of weavers pass to each other while weaving: moving back on the ends, forward in the middle, starting positions as in the Standard Double Weave. All three opposing pairs pass simultaneously. In order for this to work, pass twice (on base count) while in the end positions, and pass once while in the middle. Weavers pass in 6-count in the standard version, but since they're in sync you can easily do other counts. 4-count is pretty tough, but 5-count is fun!

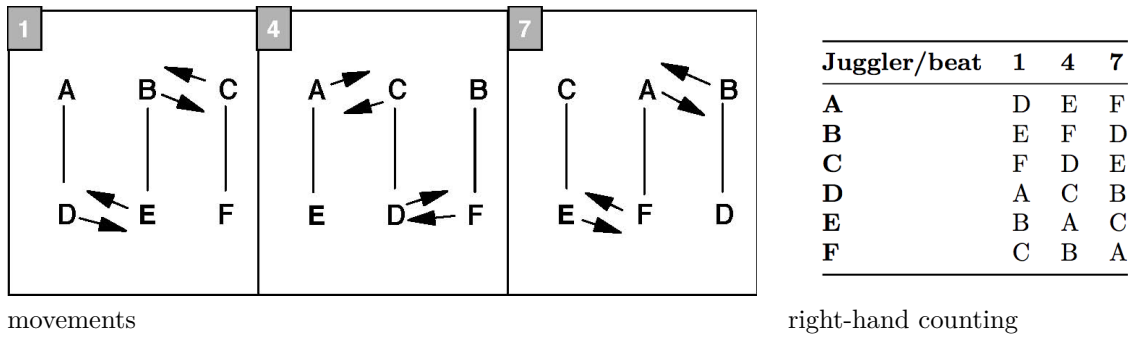

In the figure above, lines indicate passes, numbers indicate the passing beat, and arrows indicate movement after the pass. So starting out Jugglers A and F are stickers.

Note: If each side moves on the edges and middle of a rectangle, instead of weaving, we have the essence of Han's Delight. [Euro '98'].

When was this pattern created? We have been doing it since 1993 (when we did it in Tripp Commons with Matt Henry!).

Five Person Weave (Peter Feeds Five)

This is a fun moving pattern that's pretty simple but mentally tough for beginners, since the count changes as you move through the weave. The local rule is pass to Peter (the feeder) then move to the next spot. If you're in an odd spot, then you move back away from Peter and *with the grain* (i.e. in the same direction as Peter's sweep); if you're in an even spot then you move forward and *against the grain*. You end up passing more frequently in the middle and less frequently on the ends.

Juggler/beat	1	2	3	4	5	6	7	8	9	10
A	F							F		
B		F							F	
C			F			F				
D				F			F			F
E					F					
F	A	B	C	D	E	C	D	A	B	D
	11	12	13	14	15	16	17	18	19	20
A	F			F						
B						F			F	
C			F							F
D							F			
E		F			F			F		
F	A	E	C	A	E	B	D	E	B	C

- Right-hand counting

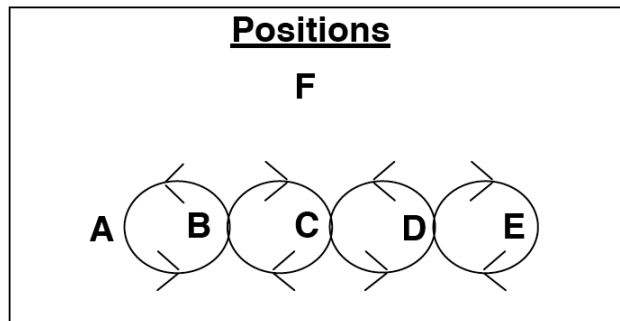

When was this pattern created? We have been doing it since 1998.

Spiral

Peter and Luke have complained that this shouldn't be called a Spiral, but that's what we call it! It's sort of a weave, but there are three loops instead of two. And you pass at the faces of the loops instead of on the edges. The standard version has weavers in 6 count (two doing every third rights and two every third lefts) and feeders in 3 count.

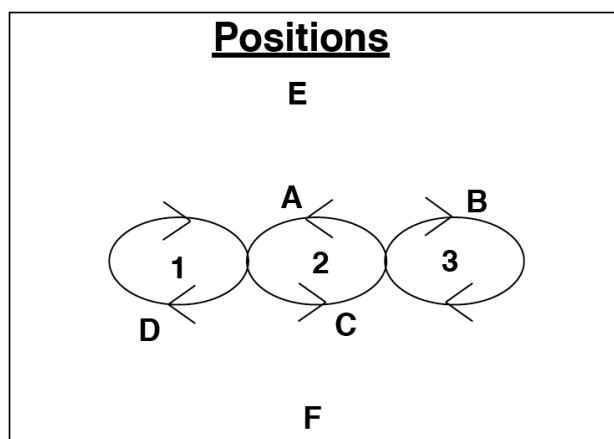

Juggler/beat	1	2	3	4
A		E		F
B	E		F	
C		F		E
D	F		E	
E	B	A	D	C
F	D	C	B	A

positions

- Right-hand counting Fast Spiral Weave [weavers 4-count; feeders 2-count]
- 3-Count Standard Spiral Weave [weavers 6 count; feeders 3-count]
- double 3 Count Hyper-Spiral Weave [not sure if we ever got this to work!]

Refer to the graph above to follow A's path through the pattern. A's first pass is to E. A then turns around and moves to the bottom of loop 1 where a pass is made to F. A turns and moves to the top of loop 1 to pass to E. A turns and moves to the bottom of loop 2 to pass to F. A turns and moves to the top of loop 3 to pass to E. A turns and moves to the bottom of loop 3 to pass to F. A turns and moves to the top of loop 2 where the pattern started.

Jugglers A, B, C, and D all do the same thing on pass out of phase. If the numbers show right hand counting this is the Fast Spiral and the weavers have a 4-count to move between each position. This is very fast.

To slow the pattern to 3-count, change the column numbers in the table above from 1, 2, 3, 4 to 1, 4, 7, and 10, and change "Right-hand counting" to "Both hands counting, right hand starts". The weavers will pass in 6-count (note that 2 weavers, A and C are passing left handed 6-count).

Still too fast? Change the column numbers to 1, 3, 5, and 7 with right hand counting (weavers in 8-count).

Like many patterns, Spirals can be stacked, where one of the feeders is replaced another Spiral with the original feeder moved to the other side of the additional Spiral.

To red line this pattern have the feeders throw double 3 count, but keep the same passing order. Now the weavers are all in 3-count. The Hyper Spiral should be enough to challenge the most jaded of weavers!

Pattern by Mike Newton and MAJ.

Standard 5-Weave

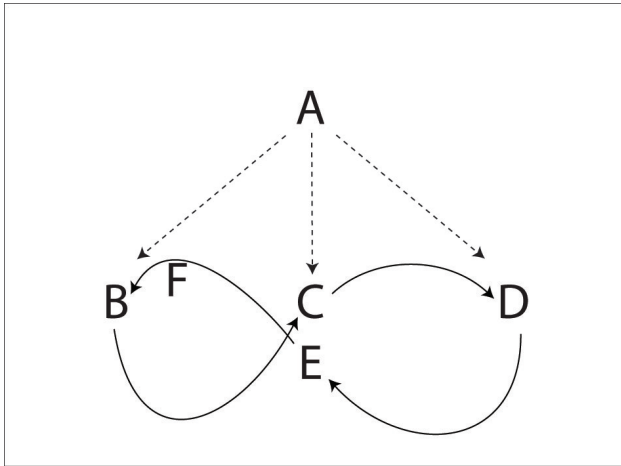

The standard weave for 1 feeder and 5 feedees has each feedee in 10-count (every 5th right) and the feeder in 2-count. Each weaver passes once on the end, moves backwards and inside, then passes once in the middle, and moves forwards and outside to the other end. A 10-count sound very slow, but I think you'll find most weavers will not be bored at all trying to keep up.

Once it starts, it's pretty easy to keep going. The start is a bit different from the standard weave for 3. The first weaver who passes in the middle goes to the opposite side of the first outside pass.

1. A – B end (B goes back on the end)
2. A – C middle (C move slowly forward and to their right)
3. A – D end (D goes back on the end)
4. A – E middle (E moves forward and to their left)
5. A – F end (F moves slowly left before the pass, then back on the end)
6. A next passes to B in the middle (as B is moving to their right) and continues passing to each weaver in order, but in the next weave position.

All of the weave variations can be done in a 5 Weave too. For added fun and excitement try a double weave of 2 standard 5 weaves, or 5 weave opposite a 3 weave, or a 5 weave opposite a Gandini Weave and so on.

Also see Twister 5 variations.

Pattern by MAJ.

Gandini 5 Weave

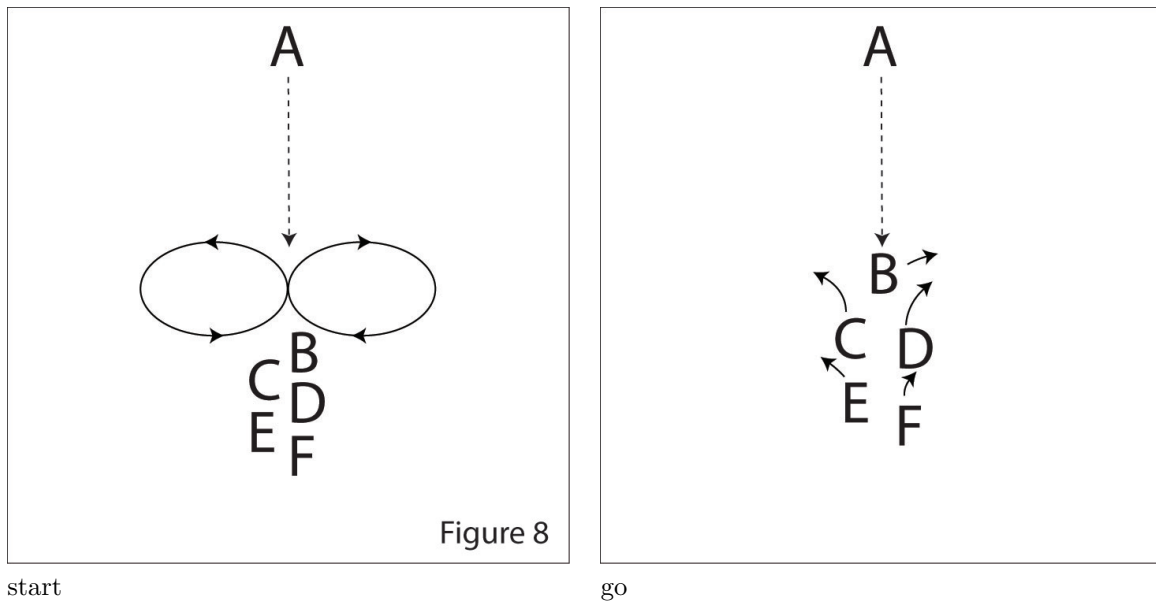

In this weave all the weavers move in a figure 8, but they always pass from the middle instead of the end. The feeder is in 2-count (every right hand pass), the feedees are in 10-count.

Juggler/beat	1	2	3	4	5
A	B	C	D	E	F
B	A				
C		A			
D			A		
E				A	
F					A

It's easiest to start with the weavers stacked in a line all facing the feeder. Then each weaver will pass once and move in the opposite direction of the weaver in front of them.

Try all the same variations for the Standard Weave and Gandini Weave, and alternate counts such as 2 of 3 count. You can also invert the weave (reverse cascade). Also see Appendix C.

We learned about this family of weave variations from juggling with Sean Gandini and the Gandini Juggling Project in 2000.

Twister 4 Weave

Twister Weaves can be done with any number of jugglers. Here's a twister weave for 6.

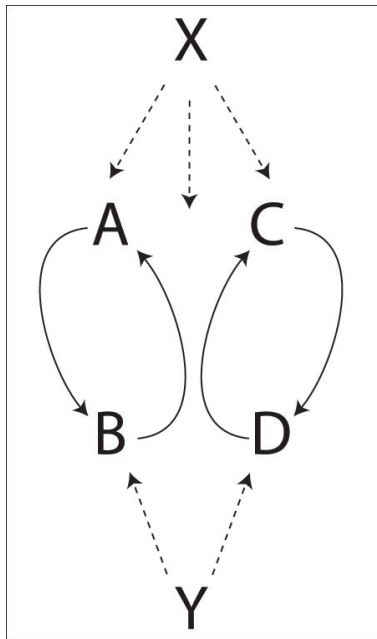

positions

Juggler/beat	1	2	3	4	5	6	7	8
X	A	B	C	D	B	A	D	C
Y		D		A		C		B
A	X			Y		X		
B		X			X			Y
C			X			Y		X
D		Y		X			X	

right-hand counting

Pattern by Luke Emery.

Foie-Graham

This is an intense off-set double-weave for six jugglers. As you enter an *outside* loop of your weave you do *pass-self-self* (right-hand counting) as usual for a weave. But as you enter the other loop, the *inner* loop, you make a series of 4 passes, starting and ending with the same person, and getting the other two in between. It takes advantage of the fact that coming out of the middle on a weave you are in front of your other weavers, and so can get some extra passes in before going to the backside of the weave loop. The position graph, on the left below, shows the 12 spots of a standard weave, duplicated and offset to configure the pattern. Blue arrows indicate moves after each beat, with the starting configuration shown. The pass graph, on the right, shows where passes happen (green) in the 12-beat cycle. (Thanks Conner for the pattern name!)

positons						
	A	B	C	D	E	F
1	1	9	5	5'	9'	1'
2	2	10	6	6'	10'	2'
3	3	11	7	7'	11'	3'
4	4	12	8	8'	12'	4'
5	5	1	9	9'	1'	5'
6	6	2	10	10'	2'	6'
7	7	3	11	11'	3'	7'
8	8	4	12	12'	4'	8'
9	9	5	1	1'	5'	9'
10	10	6	2	2'	6'	10'
11	11	7	3	3'	7'	11'
12	12	8	4	4'	8'	12'

passes						
	A	B	C	D	E	F
1	F					A
2		E			B	
3		D	E	B	C	
4	E	F			A	B
5		E			B	
6			D	C		
7	D		F	A		C
8		D	E	B	C	
9			D	C		
10	F					A
11	E	F			A	B
12	D		F	A		C

Pattern by Graham Paasch.

6-Person Turbo Variations

Interlocking Turbos

The Turbo pattern for 3 jugglers lends itself to lots of variations. This is a pattern of 2 Turbos side by side where during each transition the weaver moves from one of the Turbos to the other.

Three of the jugglers always do an “inside turn” (turning towards their right hand pass). Three of the jugglers do an “outside turn” (turning away from the right hand pass). A, B and C will always go on the outside when they cross with the other Turbo. D, E and F always go on the inside.

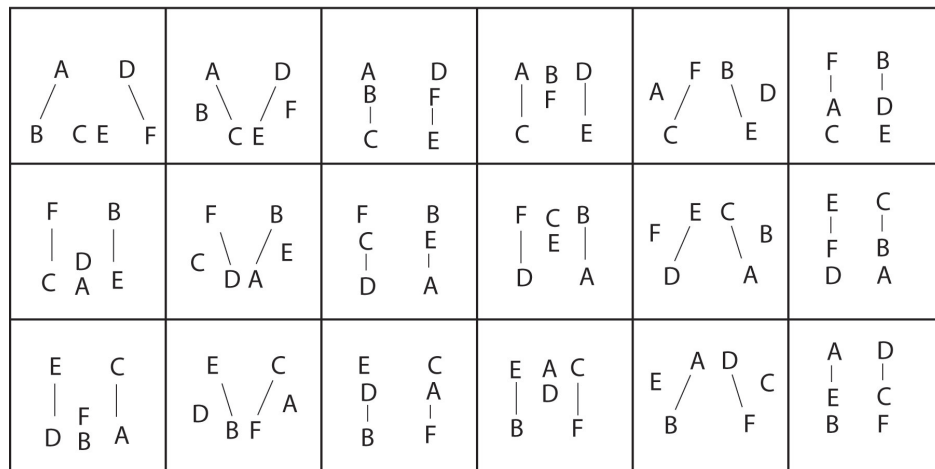

The standard pattern is in a 2-count Turbo. You can do it in 4-count or 3-count to slow it down.

Try in Tom's Turbo for a good challenge. The Interlocking Extra Club Turbos is a formidable challenge for the those with time, talent and hubris.

Pattern by Luke Emery, 1999.

Back to Back Turbos

Two Turbos are back-to-back. There are 2 situations concerning the switching of sides. When you are on one side of a turbo, you weave as you would in the regular turbo. In box 2, B and E switch sides in regular turbo style. When you are on the other side of the turbo, you move to the other turbo. In box 5, A and F switch turbos.

The movement arrows in the graph below are an approximation. In other words, you should move as soon as you can.

Lines indicate passes, and arrows indicate movement.

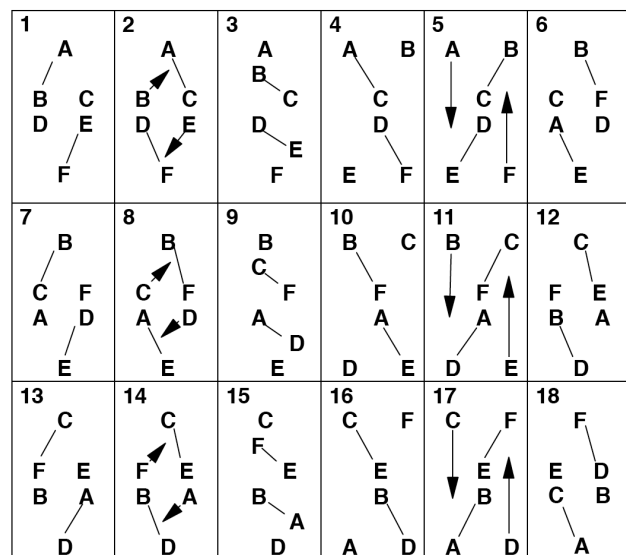

Pattern by Luke Emery, September 1999.

Ball Bearing

Here's a nifty extension of the 4-person Feast.

Positions

Juggler/beat	1	2	3	4	5	6	7	8
A	D	E	B	C	D	F	B	C
B	C	D	A	E	C	D	A	F
C	B	F	D	A	B	E	D	A
D	A	B	C	F	A	B	C	E
E		A		B		C		D
F		C		D		A		B

positions
right-hand 4-count

A, B, C, and D are doing a Feast (in 4-count), but the self throw is replaced with a pass to one of the movers in the middle. A, B, C, and D are passing 4-count. E and F are passing 8-count.

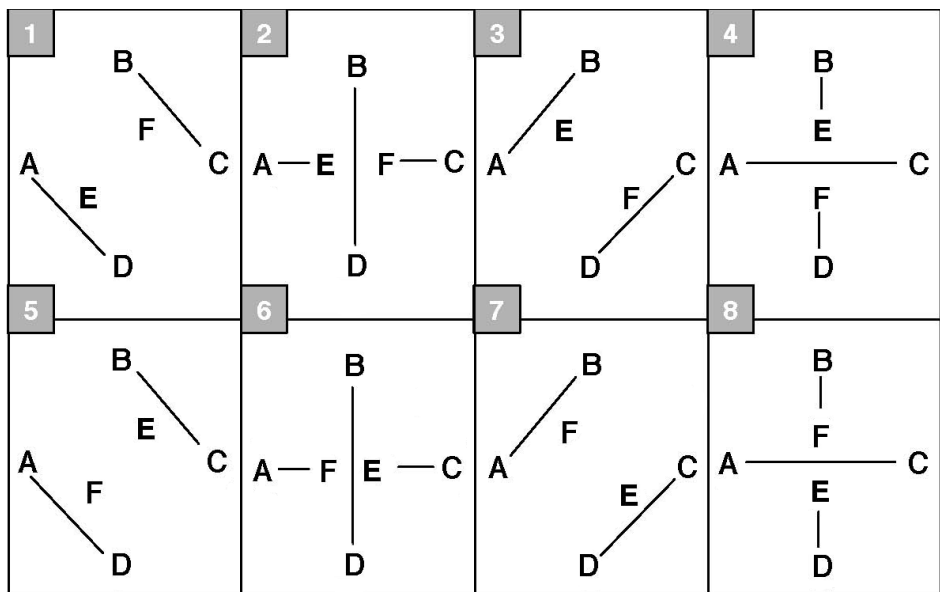

Variation: A,B,C, and D pass 3-count, and E and F pass 6-count. Start the variation with the left hand (or start on 2nd beat).

Pattern by Mike Newton.

Benzene Ring (6 person)

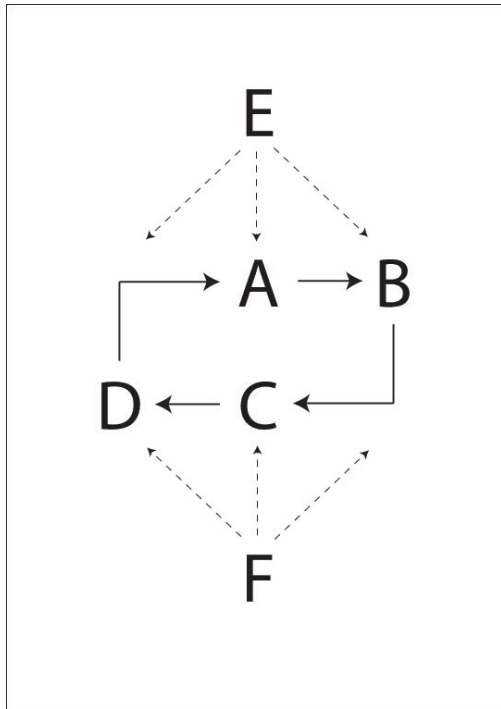

Here's another MAJ standard. E and F are carriage return feeders, feeding to 3 positions: left, middle, right, left, middle, right, etc. The rest of the jugglers move around in a ring, passing to the feeders. They pass 3 times to each feeder and then turn around to pass 3 times to the next feeder.

Juggler/beat	1	2	3	4	5	6	7	8	9	10	11	12
A		E		E		F		F		F		E
B	E		F		F		F		E		E	
C		F		F		E		E		E		F
D	F		E		E		E		F		F	
E	B	A	D	A	D	C	D	C	B	C	B	A
F	D	C	B	C	B	A	B	A	D	A	D	C

- Right-hand counting

Lets look to see what B does. B passes to E on the first beat and then has one right hand self to turn around and make the first pass to F. Then B moves to the middle (to where C is in the graph above). After B passes to F (beat 5 in the above table), B moves to where D is in the graph above. B makes one more pass to F before turning around to repeat the 3-pass cycle with E.

A, B, C, and D pass every other right hand. E and F pass every right hand.

Benzene Ring Plus

A challenging variation is to add two clubs to the pattern so that E and F do a 2-count extra club typewriter feed. All passes are doubles.

Also see Benzene Ring for 8 Jugglers

Benzene Ring Pattern by Mike Newton.

Double-Handled Egg Beater

I can't imagine why you would want an egg beater with 2 handlers, but if you did, and it was made of weaving jugglers, it might look like this.

Juggler/beat	1	2	3	4	5	6	7	8
A		C	D	F	C		D	E
B		D	C	E	D		C	F
C		A	E	B	A	F	B	
D		B	F	A	B	E	A	
E			C		B	D		A
F			D	A		C		B

- Right-hand counting

E and F are handles, A and B are one beater, and C and D are the other beater.

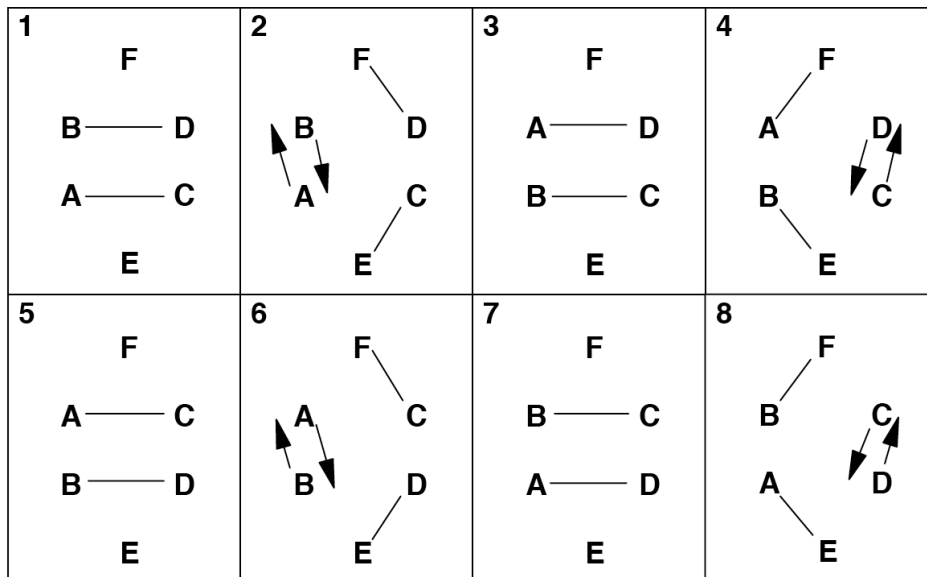

Pattern by Mike Newton and MAJ.

Razor

A and B move around one circle, and C and D move around another circle. The table below is in 3-count, and is very fast. Try 4-count, or even 6-count to start.

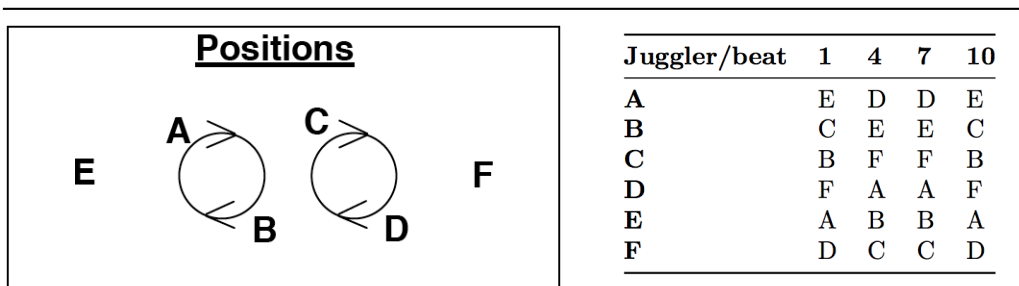

positions

both-hands counting (right start)

The numbers in the table below count the passes.

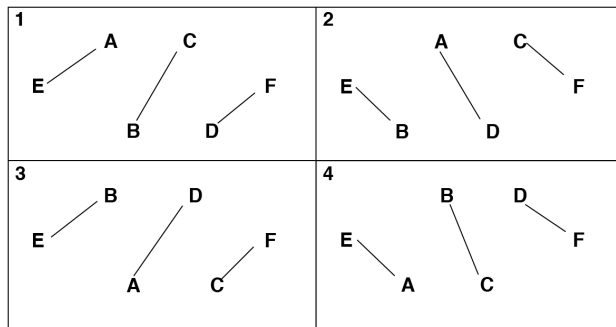

In the parlance of stacking patterns, this one is a 1-2-2-1: olive, spinning 3-count pair; spinning 3-count pair; olive.

Pattern by Peter Kaseman and the MAJ.

Electric Razor

The Electric Razor is 3 pairs of jugglers of spinning 3 counters.

Positions

1		2	
3		4	

Juggler/beat	1	4	7	10
A	E	C	C	E
B	D	F	F	D
C	F	A	A	F
D	B	E	E	B
E	A	D	D	A
F	C	B	B	C

positions

passes

both-hands counting (right start)

The numbers in the table above count passes.

The Electric Razor pattern was invented by Peter Kaseman, summer '98.

Two-Seated Unicycle

Juggler/beat	1	4	7	10
A	C	D	D	C
B	A	A	A	A
C	B	E	E	B
D	E	B	B	E

Juggler/beat	1	4	7	10
E	F	F	F	F
F	D	C	C	D

- Both hands counting, right hand starts
- B does drop-back passes to A.
- E does drop-back passes to F.

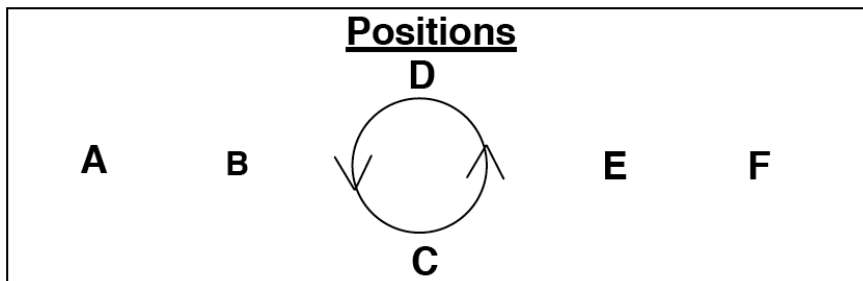

Arrows indicate the direction of pass.

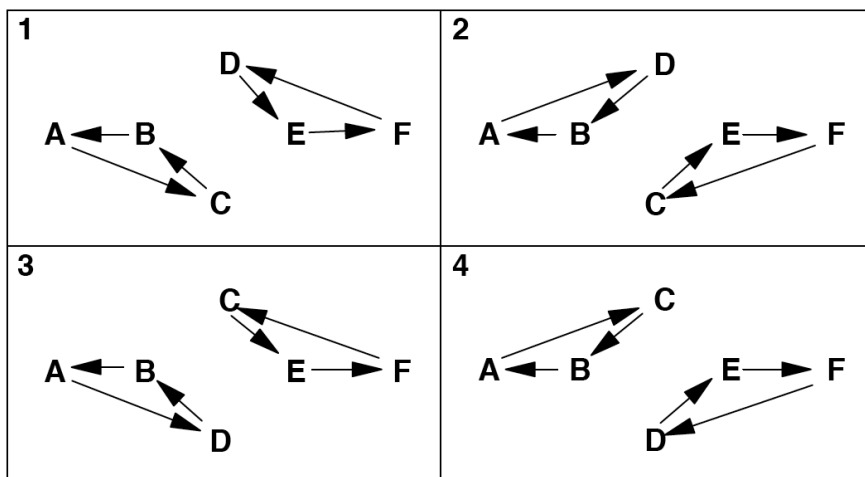

Pattern by MAJ.

Mel's Big Woody

Standard:

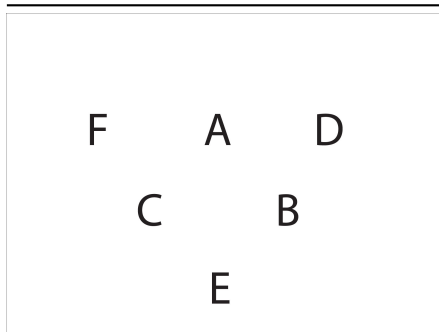

Juggler/beat	1	2	3	4	5	6
A	D	B	C	F	C	B
B	E	C	A	D	A	C
C	F	A	B	E	B	A
D	A			B		
E	B			C		
F	C			A		

positions

Right-hand counting

Variation:

Now, to make it more interesting, throw early triples from the corners.

Juggler/beat	1	2	3	4	5	6
A	D	B	C	F	C	B
B	E	C	A	D	A	C
C	F	A	B	E	B	A
D	A	T-F	Pause	B	T-E	Pause
E	B	T-D	Pause	C	T-F	Pause
F	C	T-E	Pause	A	T-D	Pause

- Right-hand counting

D, E and F can pirouette in their Pause for some extra showmanship.

Trompe L'oeil (Concentric Triangles)

Here's an extension of the 4-count extra club triangle to 6 jugglers. All the jugglers should be quite comfortable with 4-count extra club triangles.

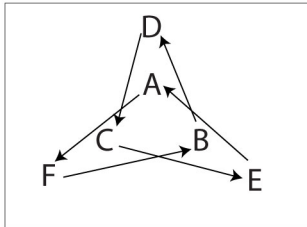

- A – Double to F, self
 - D – Double to C, self
 - C – Double to E, self
 - F – Double to B, self
 - B – Double to D, self
 - E – Double to A, self
- All passes right handed. 2 extra clubs (A , and D start with 4).

This is the 4-count version.

There are also nice variations in 6 count doubles (with 1 extra club), 7 club 3-count (2 extra clubs and same pattern a 4-count, just slower), 2-count doubles (3 extra clubs - A, B and C all start with 4), and if you're feeling crazy, chocolate bar (PPSSSS) or 1 – count (2 extra clubs and 6 extra clubs respectively).

This is an extension of a pattern Matt learned at a juggling convention where the same formation juggles without extra clubs in whatever count they choose (4-count being standard).

Pattern by That Matt (Matt Mella).

Overlapping Y's

Positions							
A							
B C							
D	E F						

Juggler/beat	1	2	3	4	5	6
A	E	E		F	D	
B		D			E	
C	F			E		
D		A			B	
E	C	B		A	A	
F	A			C		

positions Both-hands counting

You can do a nice 1-count variation similar to this too.

Pattern by MAJ.

More Mating Oogles

Imagine better looking oogles mating than the previous mating oogles. This is basically a 1-count Oogle variation with a 2-count left handed Y and a 2-count right handed Y superimposed.

A B C D		
Y		
X		

Juggler/beat	1	2
X	D	A
Y	B	C
A		Y
B	X	
C		X
D	Y	

positions Both-hands counting

- X throws rights to D and lefts to A
- Y throws rights to B and lefts to C
- A throws left hands to Y and does right selves
- B throws right hands to X and does left selves
- C throws left hands to X and does right selves
- D throws right hands to Y and does left selves

Pattern by MAJ.

Fireworks

Do you have nerves of steel? Do you juggle with poise and confidence while bombs explode all around you and other jugglers panic and dive for cover? Good, you'll need all of that for this pattern. It is a right handed pattern with 4 extra clubs and lots of doubles and triples. Sometimes, (maybe even often, for some jugglers), those collide above your heads.

However, if thrown carefully, there is just enough room for all of them.

Juggler/beat	1	4	7	10
A	T-D		D-E	
B		D-F		D-D
C	D-E		T-F	
D	D-B		T-A	
E		D-A		D-C
F	T-C		D-B	

- Both hands counting
- A, C, D and F start with 4 clubs and right hands
- B and E start with 3 clubs and left hands

The corners do a 2-count feed of triples to the opposite corner and doubles to the centers. The centers do a 2-count feed of doubles to the corners.

Pattern by Luke Emery. **Q: what is the layout?**

Theatre Style Popcorn

This impressive pattern with 21 clubs is in the same family as the Oogle and the Apollo and is a Madison favorite.

- A does a typewriter feed to D, E and F in 8 club 2-count (triples).
- B does a typewriter feed to D, E and F in 7 club 2-count (doubles).
- C does a typewriter feed to D, E and F in 6 club 2-count (crispy singles)
- D, E and F do popcorn passing: triple to A, double to B, single to C.

Juggler/beat	1	2	3	4	5	6
A	T-D		T-E		T-F	
B		D-D		D-E		D-F
C	E		F		D	
D	T-A		D-B		C	
E	C		T-A		D-B	
F	D-B		C		T-A	

positions
Both-hands counting

- All passes from right hand
- A, C, D, E, F start with right hand

- A, D and F start with 4 clubs
- B starts with left hand

As you might expect, A is a challenging position. C, less so.

Pattern by Peter Kaseman.

Windy Two Holer

This has quickly become a classic six-person pattern; not sure who invented it, but Mel was there, and it was a windy day on the Library Mall. Despite its full cycle being the rather lengthy 24 passing beats (rows of the tables), the windy-two-holer is pretty easy to remember, since each juggler's task repeats every 6 passing beats. This is fun in 4-count, 3-count, and even 2-count for those not faint of heart. All jugglers juggle in sync but move in turn. Six jugglers arrange around a circle inscribed with eight spots: 1,2, ... 8, let's say. The spots are not in the obvious order around the perimeter, but rather they're in the order of the figure below, corresponding to the corners of two inscribed squares. Now the six jugglers can cover only six of the eight spots. There are two *holes*, known technically (and affectionately) as the *A-hole* and the *number-2 hole*. In the start indicated by the first row of the table, the A-hole is position 8 and the number-2 whole is *becoming* position 1. Jugglers A, B, and C move around the yellow square, starting in positions 7, 6, and 5, respectively. After the first beat, juggler A moves into the A-hole, whereby position 7 becomes the new number-2 hole. Likewise, jugglers D, F, and E move along the magenta square, starting in positions 3, 4, and in between 1 and 2. In fact, we always start with E in already landed in position 2, but a proper start would have E on the move at the beginning. Each juggler only ever passes to the two others in his/her square, never to the other square. The local passing rule, in the steady state (and counting on the passing beat) is *pass one - pass other - self - pass one - pass other - move/self*. At any passing beat one pair from each square is passing, and collisions are avoided because the two passing sets are parallel; e.g. on beat 1 below, jugglers A and C exchange along the diagonal of the yellow square while jugglers D and F exchange along the parallel line 3-4.

POSITIONS						
	A	B	C	D	E	F
1	7	6	5	3	1-2	4
2	7-8	6	5	3	2	4
3	8	6	5	3	2	4-1
4	8	6-7	5	3	2	1
5	8	7	5	3-4	2	1
6	8	7	5-6	4	2	1
7	8	7	6	4	2-3	1
8	8-5	7	6	4	3	1
9	5	7	6	4	3	1-2
10	5	7-8	6	4	3	2
11	5	8	6	4-1	3	2
12	5	8	6-7	1	3	2
13	5	8	7	1	3-4	2
14	5-6	8	7	1	4	2
15	6	8	7	1	4	2-3
16	6	8-5	7	1	4	3
17	6	5	7	1-2	4	3
18	6	5	7-8	2	4	3
19	6	5	8	2	4-1	3
20	6-7	5	8	2	1	3
21	7	5	8	2	1	3-4
22	7	5-6	8	2	1	4
23	7	6	8	2-3	1	4
24	7	6	8-5	3	1	4

PASSES						
	A	B	C	D	E	F
1	C	-	A	F	*	D
2	*	C	B	-	F	E
3	B	A	-	E	D	*
4	C	*	A	F	-	D
5	-	C	B	*	F	E
6	B	A	*	E	D	-
7	C	-	A	F	*	D
8	*	C	B	-	F	E
9	B	A	-	E	D	*
10	C	*	A	F	-	D
11	-	C	B	*	F	E
12	B	A	*	E	D	-
13	C	-	A	F	*	D
14	*	C	B	-	F	E
15	B	A	-	E	D	*
16	C	*	A	F	-	D
17	-	C	B	*	F	E
18	B	A	*	E	D	-
19	C	-	A	F	*	D
20	*	C	B	-	F	E
21	B	A	-	E	D	*
22	C	*	A	F	-	D
23	-	C	B	*	F	E
24	B	A	*	E	D	-

El Turbo Plus Two Posts

Refer back to 4-person El Turbo. In **variations** see how to add one or two 4-count stationary posts when the El Turbo jugglers are on selves.

Ivy- π Weave Plus Post

Refer back to 5-person Ivy- π weave, and notice that there's a steady 4-count gap created by the the five weavers. Put a post on one side and have that juggler fill in the gap. [Summer '17]

Four Leaf Clover plus Orbiter

Refer back to 5-person 4-leaf clover. An extra passer (the orbiter) picks up passes to the movers after each one clears the middle (on their 4-out). One way is on the 2nd beat (1 beat after the star in the pattern table); the even beats 2-4-6-8-10, say passing 4-count to B-E-C-D-A. Start the orbiter just outside the line C-D and move clockwise, staying inside each feeder.

Chapter 7

7 Person Patterns

Here are some easy stationary patterns for a group of seven.

Feast

Everyone feeds everyone else on count of choice.

1-2-4 Apollo

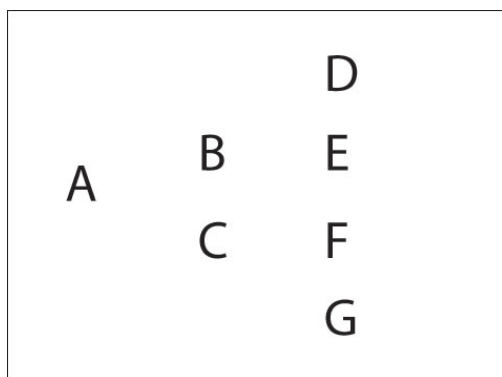

positions

Juggler	1	2	3	4
A	D		G	
B	F	E	D	E
C	G	F	E	F
D	A		B	
E		B	C	B
F	B	C		C
G	C		A	

Right-hand counting

A throws long passes in 4-count to D and G

B and C each do sweep feeds of 3.

D and G do 4-count between A and the feeder on their side

E and F do a sweep feed with a phantom (don't pass to the phantom)

See the spaceship?

As with other big easy patterns, it's fun to *rotate*, i.e., to switch positions after you master one setting.

Pattern by MAJ.

Hinge

Positions		
A		
B	F	
C	D	E
	G	

positions

Juggler	1	2	3	4
A	F			
B		F		F
C	G		F	
D		G		G
E			G	
F	A	B	C	B
G	C	D	E	D

Right-hand counting, or other
C is the hinge, passing to both feeders
Feeders F and G do standard feed of 3

Variations: Precious Metal Hinge. Escalate any line with doubles and an extra club (see Big Patterns chapter for more details).

Hinge created by Mike Newton; precious metal variations must have been by Luke or Peter!

Overlapping Chocolate Bar 3-count Feeds

The old-school 5-person Chocolate Bar 3-count Feed has two chocolate bar feeders and 3 3-count feedees. This recent extension for seven overlaps two copies of the classic, with the 3 overlapping positions becoming very cool. In fact Juggler B does a pretty special 1-count. A and C continue with chocolate bar; D and G do 3-count; and E and F do 3/2-count.

A B C
D E F G

7 jugglers/ both hands counting	1	2	3	4	5	6	7	8	9	10	11	12
A	D	E			E	F			F	D		
B	E	F	F	D	F	G	D	E	G	E	E	F
C			G	E			E	F			F	G
D	A			B			B			A		
E	B	A		C	A		C	B		B	B	
F		B	B		B	A		C	A		C	B
G			C			B			B			C

positions

passes

On to moving patterns.

Open Face Sandwich

Refer to 9-person Twister Sandwich. Replace one of the end weaves with a single 2-count feeder (an olive). In stacking notation, a 1-3-3: *olive; double-time-twister; standard weave.*

The Blast

This pattern became an instant Madison classic. Although the basic pattern is straight forward, there are a vast array of extensions and variations that can easily be tuned for the skill levels and number of available jugglers.

Juggler	1	2	3	4	5	6	7	8	9	10
A	D	E	C	G	E	F	G	D	F	C
B	F	G	D	F	C	D	E	C	G	E
C			A		B			B		A
D	A		B			B		A		
E		A			A		B			B
F	B			B		A			A	
G		B	A				A		B	

- Right-hand 4-count base

The weavers move in 8-count in the middle and 12-count on the ends. It's not difficult, but certainly not as boring as 8-count and 12-count might seem at first glance. Dotted lines are passes and solid lines are movement.

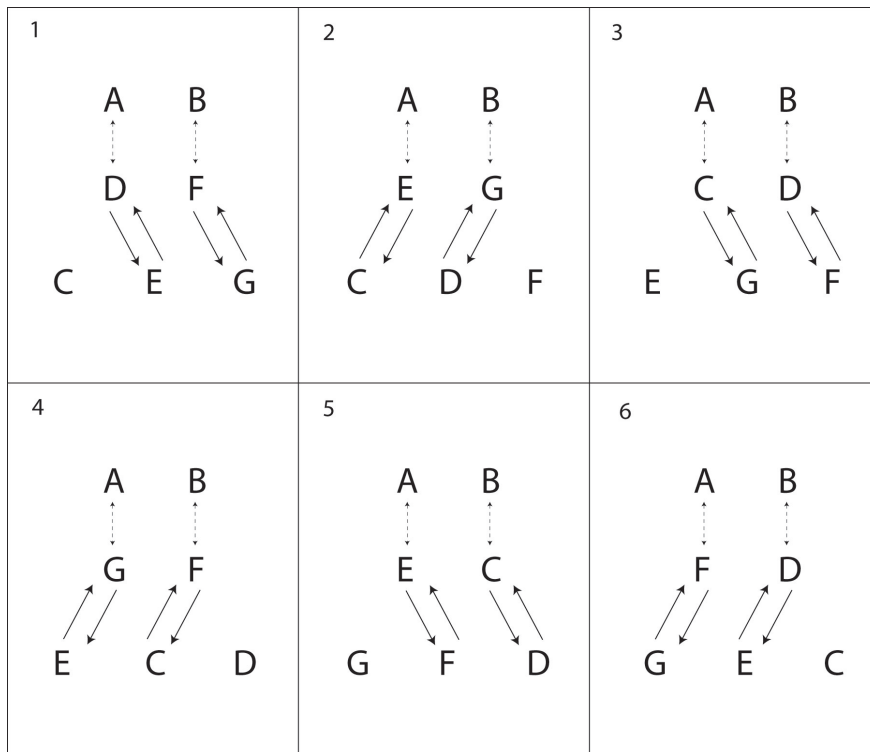

Try the pattern in chocolate bar, or do a pirouette underneath a self triple while doing 12-count on the ends. See other variations in Fully Loaded Blast underneath Big Patterns, including some very challenging and fun extensions.

This pattern was created by Peter Kaseman and was inspired by a bouncing ball pattern.

Broken Hearted Blast

Using the same passing table as above, change the movement. Instead of a **W**, go behind the feeder line after you make your second *inside* pass, and thus as you go into your 12 count. We convinced ourselves that the long motion past the feeders and back looks like half of a heart-shape. Taking into account the stagger needed to let another juggler pass in front gave us the name!

Wonky Benzene Ring

Refer ahead to the original, 8-person, Benzene Ring. Drop one mover, leaving 5 movers, and retain 2 feeders. One feeder feeds 4 spots and the other feeder feeds 3 spots. The feedees do 4 count on the side that has 3 spots and 6 count for the side that has 4 spots. You start your new count as soon as you turn (only one right handed self after you finish on the side with 4 spots).

Pattern by Peter Kaseman.

Twister-5's

These arise from the 6-person Gandini-5 Weave by adding a second feeder (*hand*) on the opposite side of the pattern (and thus defying gravity!).

Original Twister-5

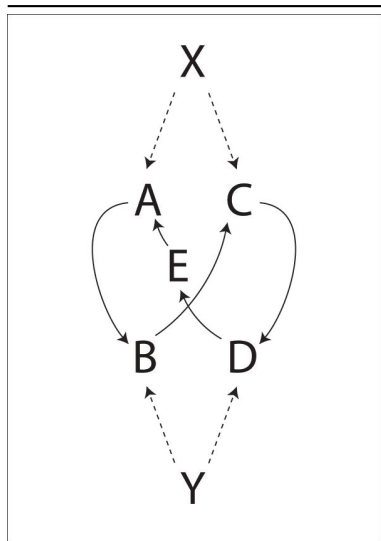

positions

Juggler	1	2	3	4	5	6	7	8	9	10
X	A		C		E		B		D	
Y		B		D		A		C		E
A	X					Y				
B		Y					X			
C			X					Y		
D				Y					X	
E					X					Y

Right-hand counting

Variations: Add passes, clubs, or change the count.

Double Time Twister 5

The feeders pass twice in a row to each feeder.

Twister-5 Plus

Add an extra club over the top with X and Y passing 7 club 4-count on their self throws. This was a Mad-5 favorite one year; we performed it at the Cascade of Stars in the 2000 IJA Festival.

Twister-5 7-then-8-Count

The feeders throw 3-count and the weavers pass 7 count on one leg, and 8 count on the other.

Twister-5 5-Count

X throws 2-count right handed. Y throws 2-count left handed. The weavers do 5-count. Fun!

Twister-5 Sandwich

Like the Twister Sandwich in 9 Person Patterns, you can replace one or both of the feeders with a 3 person weave (or any other weave, really). To make it more interesting, try a double time weave where each weaver passes twice to the other weave.

Pattern by MAJ.

Twister Plus Plus

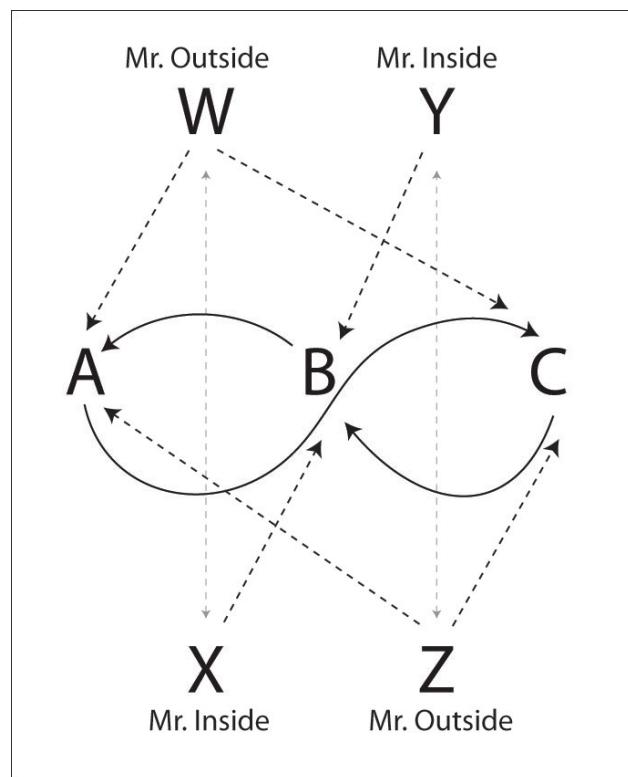

This amazing pattern is another crown jewel of the MAJ pattern repertoire. It's a combination of Twister Plus and Double Time Twister.

The feeders are all doing Twister Plus, alternating triples all the way across the pattern with singles to the weavers. The weavers are doing a Double Time Twister Weave and pass twice on each side, once to each feeder. Messrs Outside pass to the outsides, and Messrs Inside pass to the inside weaver position.

Juggler	1	2	3	4	5	6	7	8	9	10	11	12
W	A	T-X	C	T-X	B	T-X	A	T-X	C	T-X	B	T-X
X	T-W	B	T-W	A	T-W	C	T-W	B	T-W	A	T-W	C
Y	T-Z	A	T-Z	C	T-Z	B	T-Z	A	T-Z	C	T-Z	B
Z	C	T-Y	B	T-Y	A	T-Y	C	T-Y	B	T-Y	A	T-Y
A	W	Y	X	Z	W	Y	X	Z	W	Y	X	Z
B		X	Z	Y	W	Y	X	Z	W	Y	X	Z
C	Z		W	Y		X	Z		W	Y		X

- Right hand counting
- X and Y start with 4 clubs

Pattern by MAJ.

Iron Cross Weave

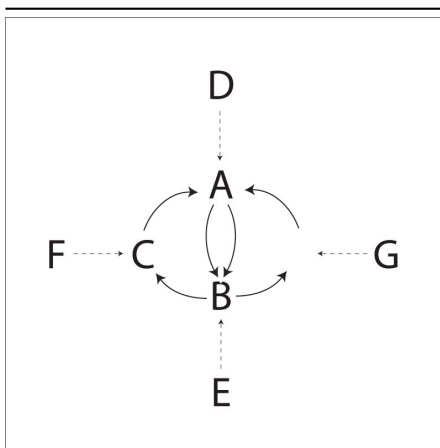

positions

Juggler	1	2	3	4	5	6	7	8	9	10	11	12
A	D	E	F	D	E	G						
B	E	G	D	E	F	D						
C	F	D	E	G	D	E						
D	A	C	B	A	C	B						
E	B	A	C	B	A	C						
F	C		A		B							
G		B			C					A		

Right-hand counting

See all those selves? Once you're comfortable with this pattern, make life more interesting by adding extra passes in the selves. One variation is for F and G to pick up the passes before and after their normal passes (so they throw pass, pass, pass, self). Another variation is for each E, F and G to all pass twice in a row to the weavers. D can't pass twice in a row without making the turn from D to E rather difficult.

Pattern by Luke Emery.

Intersecting Weave

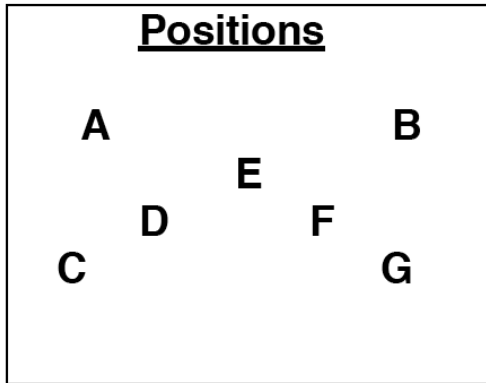

A and B are feeding a standard weave with one position common to both. The weavers do a standard weave until they get between A and B. The weaver then leaves one weaver to enter the other. During this transition, the weaver makes 2 passes in a row.

Juggler	1	2	3	4	5	6	7	8	9	10	11	12	13	14	15	16	17	18	19	20
A	C	D	F	C	D	F	G	D	F	G	E	F	G	E	C	G	E	C	D	E
B	E	F	G	E	C	G	E	C	D	E	C	D	F	C	D	F	G	D	F	G
C	A			A	B			B			B			B	A			A		
D		A			A			A	B			B			B			B	A	
E	B			B			B			B	A			A			A			A
F		B	A			A			A			A	B			B			B	
G			B			B	A			A			A			A	B			B

- Right hand counting

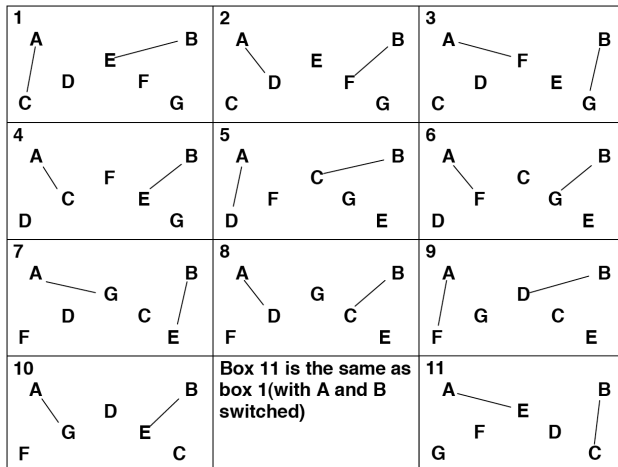

A and B are feeding a standard weave with one position common to both. The weavers do a standard weave until they get between A and B. The weaver then leaves one weaver to enter the other. During this transition, the weaver makes 2 passes in a row.

Pattern by Steve Otteson.

Eye of the Needle

A Twister Weave has lots of time and space in the middle.

If your weavers are quite comfortable with outside turns in a Twister Weave, then here is a fun and good looking pattern. This is just a Twister Weave with another passing duo embedded in the center.

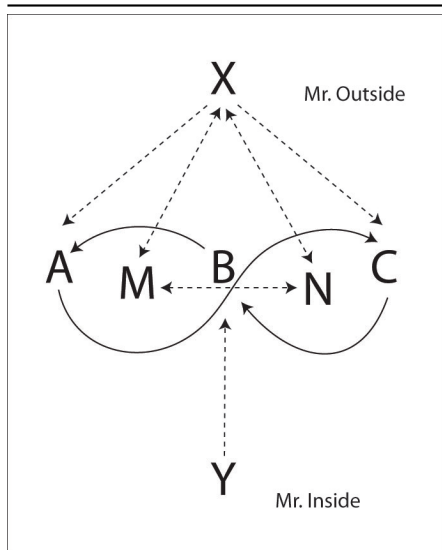

positions

Juggler	1	2	3	4	5	6	7	8	9	10	11	12
X	A	N	C	M	B	N	A	M	C	N	B	M
Y		B		A		C		B		A		C
A	X			Y			X			Y		
B		X			Y			X			Y	
C			X			Y			X			Y
M	N		N	X	N		N	X	N		N	X
N	M	X	M		M	X	M		M	X	M	

Right-hand counting

If this pattern is too challenging as written, then start by skipping the passes from M and N to X. Then M and N just do a 4-count in the middle and X does a standard Mr. Outside 4-count.

There are a number of patterns that have enough room to embed other patterns in the middle.

Pattern by MAJ.

2-5 or 1-5-1 Foie Graham

Refer to the 8-person 3-5 Foie Graham and the variations that drop one juggler.

Big Mangled Squirrel

A high-end pattern with extra clubs and change sides: refer to 5-person Mangled Squirrel, which is 2 on 3. Expand it to 3 on 4. Now the passing rule is *Triple-2-1-2-1-2*.

Chapter 8

8 Person Patterns

Feast

Everyone feeds everyone else, on count of choice.

4-on-4 line

Feed the two people opposite you, or do a baby position on the end. Use only as a warm-up!

Double vision 4's

Take any (almost any) 4 person pattern and turn each juggler into two. Double-vision boxes are nice and fun; The double-vision oogle boogie is possible too. Someone should try a double-vision shooting star, but we haven't yet!

Big Hinge minus 4

Drop all 4 baby positions from this 12 person pattern.

Polymer Weave

It's a passing axiom that any 2-count feeder can be replaced by a standard weave. If this is applied to the traditional W pattern, the result is this crazy pattern. It is called a Polymer Weave because you can add additional weaves to either end of the pattern (just like adding additional passers to a W).

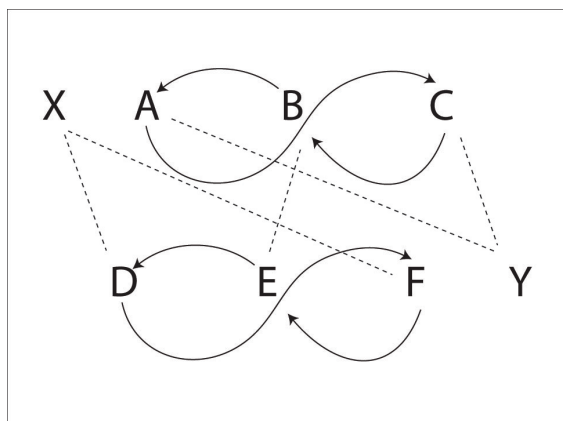

positions

Juggler	1	2	3	4	5	6	7	8	9	10	11	12
X	D	F	E	D	F	E						
Y	C	A	B	C	A	B						
A			Y		F			Y				F
B		E		Y			E				Y	
C	Y			D			Y			D		
D	X			C			X			C		
E		B		X			B			X		X
F			X		A			X				A

Right-hand counting

Pattern by Mike Newton.

Benzene Rings (for 8 Jugglers)

Original

Here's another MAJ standard. E and F are carriage return feeders, feeding to 3 positions: left, middle, right, left, middle, right, etc. The rest of the jugglers move around in a ring, passing to the feeders. They pass 3 times to each feeder and then turn around to pass 3 times to the next feeder.

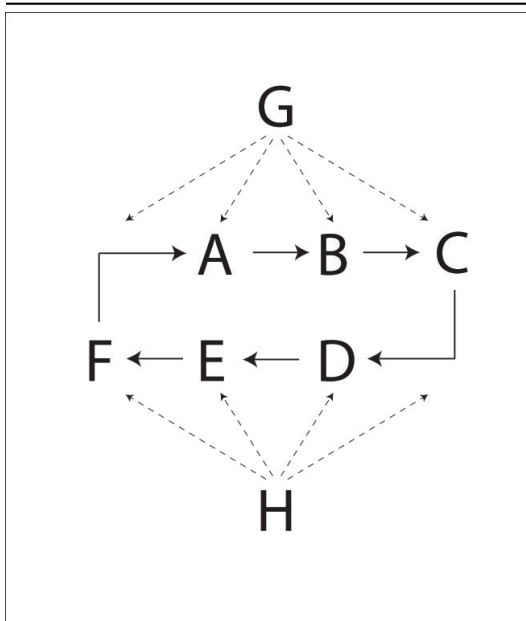

positions

Juggler	1	2	3	4	5	6	7	8	9	10	11	12
A			G			G			G			H
B		G			G			H			H	
C	G			H			H			H		
D			H			H			H			G
E		H			H			G			G	
F	H			G			G			G		
G	C	B	A	F	B	A	F	E	A	F	E	D
H	F	E	D	C	E	D	C	B	D	C	B	A

Right-hand counting

The feeders G and H feed carriage return to 4 positions (instead of 3 positions in the 6 juggler version). The movers move around the loop passing to each feeder 4 times before turning around to pass to the other feeder. The graph shows half of a full cycle. The pattern will repeat in its mirror image.

Pattern by Mike Newton and MAJ.

Variation:

Inverted Extra Club Benzene Ring.

A very cool variation of the Benzene Ring is to invert the movers, so they are all facing inward instead of outward on the elliptical path. They can't pass to the same feeder (unless by back drop), so they pass doubles over the opposing line and toward the opposite-side feeder. So it's a two-extra club pattern: double-throw then shift over on 6-count, repeat for four spots, then turn 180 and repeat. Careful about collisions! Usually feeders start with the extra clubs. To make it more fun the movers can do 3-count, by adding a single pass to their counterpart inside the ellipse! These are are lefts that are themselves 6 count; so together the movers do 3-count, alternating single inside pass double pass over the line.

Khaos Butterfly

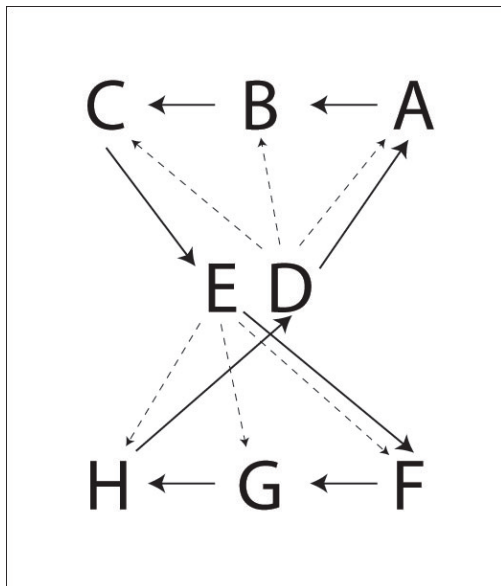

Kat's Khaos Butterfly is two standard feeds back to back. After each sweep of the feed, each juggler moves to the next position.

Solid lines are movement, dotted lines are passes.

Juggler	1	2	3	4	5	6	7	8	9	10	11	12	13	14	15	16
A				D	H		H			G			C	E	C	B
B		D				H			E	F	E	C				A
C			D		F	G	F	E				B	A		A	
D		B	C	B	A			H	G		G			F		
E		G	H	G	F			C	B		B			A		
F				E	C		C			B			H	D	H	G
G		E		E		C			D	A	D	H				F
H			E		A	B	A	D				G	F		F	

- Right-hand counting

Pattern by Kat Girdaukas.

Egg Beater Twister

Original

We tried to replace the 4-count handle of a standard Egg Beater with a Twister Weave minus one feeder. Having to resolve some line problems we got the following, which is pretty fun. Juggler A is a Mr. Inside feeder of twister weavers B, C, D, each on 6-count. Jugglers E, F and G, H form two beaters in an Egg Beater. They each do 4-count, 4-count, 8-count, with that deep pass going up to the Weave, in place of any Mr. Outside. Pink nodes show passing positions; yellow nodes are self-positions; blue edges show 2-count transitions. Green edges indicate where passes go. Letters in the graph show starting positions of the 8 jugglers

PASSES								
	A	B	C	D	E	F	G	H
1	-	F	-	-	G	B	E	-
2	C		A		-	-	-	-
3	-		-	H	-	G	F	D
4	B	A	-	-	-	-	-	-
5	-	-	E	-	C	H	-	F
6	D		-	A	-	-	-	-
7	-	G	-	-	H	-	B	E
8	C	-	A	-	-	-	-	-
9	-		-	F	G	D	E	-
10	B	A	-	-	-	-	-	-
11	-	-	H	-	-	G	F	C
12	D		-	A	-	-	-	-
13	-	E	-	-	B	H	-	F
14	C	-	A	-	-	-	-	-
15	-	-	-	G	H	-	D	E
16	B	A	-	-	-	-	-	-
17	-	-	F	-	G	C	E	-
18	D	-	-	A	-	-	-	-
19	-	H	-	-	-	G	F	B
20	C	-	A	-	-	-	-	-
21	-	-	-	E	D	H	-	F
22	B	A	-	-	-	-	-	-
23	-		G	-	H	-	C	E
24	D	-	-	A	-	-	-	-

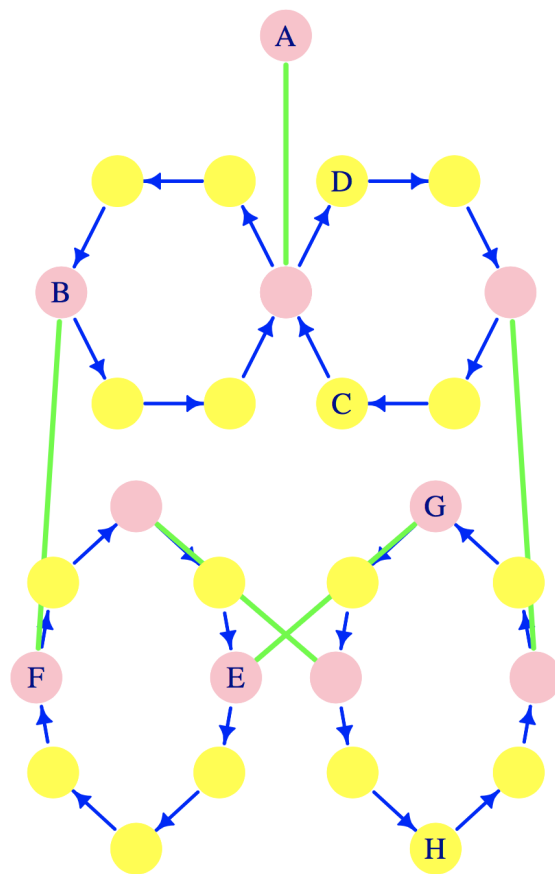

positions

Right-hand counting

Everyone Moves

Like above, but after your Mr. Outside pass in the weave you move into the Egg Beater; and after your Egg Beater loop you head back into the center of the Weave. As the figure below shows, this slightly modifies the previous graph by redirecting 4 blue edges. It takes folks who are good at twisters and egg-beaters, but we did it at 2017 Madfest if memory serves.

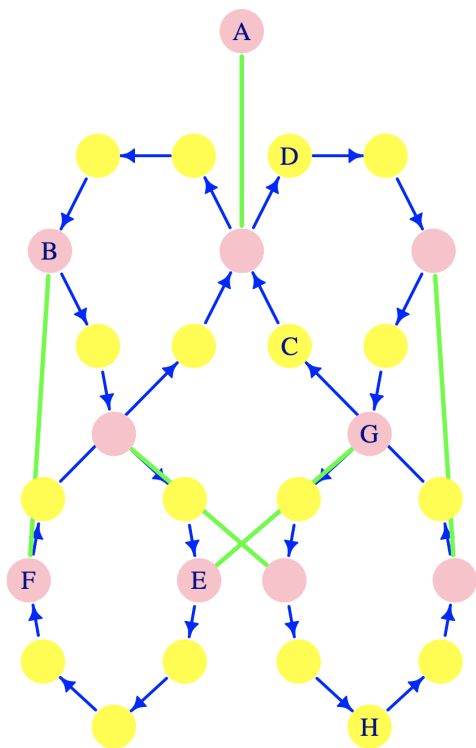

3-5 Foie Graham

This is really fun pattern for 8 good weavers.

Refer to the video from Nov 30, 2017, MAJ¹, in which A=Mark, B=Conner, C=Mel, D=Jeff, E=Chan, X=Graham, Y=Mike, Z=Peter. As the table below indicates, passers A-E do 4 of 10 rights; passers X-Z do 4 of 6 rights. The figure below shows all positions in the pattern (nodes) and 1-beat transitions (blue edges); the starting configuration is also shown; pink nodes indicate passing positions and yellow are self beats. Two pairs pass on every right-hand beat (e.g., starting Z-E and X-C). In the steady state A-E each do pass-pass-self-self-pass-self-self-pass-self-self; X-Z do pass-pass-pass-pass-self-self; all right-hand counting. Not counting selves, it's also neat that each of A-E pass in sequence to X, Y, then Z; never in another order. There's also a curious letter shuffling going on from the perspective of X,Y, and Z. Of all possible ordered sets of 4 from 5, only 5 appear as the passing sequences of X, Y, and Z. And they do them in the same order, but out-of-phase: EDDBA-CEDDBA-ACED-DBACE-DBAC, thanks to the dynamics of the two weaves. It's interesting that to go from one to the next you append the non-passed-to juggler (prefix) to the first-three of four (suffix). E.g. EDDBA goes to CEDDBA. Passing repeats after 30 right-hand beats (see table), but a full cycle is 60 right-hand beats to get back into the starting places! Notice also there are 20 positions in the 5-weave (5 positions on each of 4 loops), which makes it a slightly faster loop than a typical weave (which has 6 positions per loop and 3 loops).

¹<https://photos.app.goo.gl/fajhq73DfffttDfm1>

PASSES								
	A	B	C	D	E	X	Y	Z
1	-	-	X	-	Z	C	-	E
2	-	Y	-	Z	-	-	B	D
3	Y	Z	-	-	-	-	A	B
4	-	-	Y	-	X	E	C	-
5	-	-	-	X	Y	D	E	-
6	Z	X	-	-	-	B	-	A
7	X	-	Z	-	-	A	-	C
8	-	-	-	Y	Z	-	D	E
9	-	Y	-	Z	-	-	B	D
10	Y	-	X	-	-	C	A	-
11	-	-	Y	-	X	E	C	-
12	-	B	-	X	-	D	-	B
13	Z	X	-	-	-	B	-	A
14	-	-	Z	-	Y	-	E	C
15	-	-	-	Y	Z	-	D	E
16	X	Y	-	-	-	A	B	-
17	Y	-	X	-	-	C	A	-
18	-	-	-	Z	X	E	-	D
19	-	Z	-	X	-	D	-	B
20	Z	-	Y	-	-	-	C	A
21	-	-	Z	-	Y	-	E	C
22	-	X	-	Y	-	B	D	-
23	X	Y	-	-	-	A	B	-
24	-	-	X	-	Z	C	-	E
25	-	-	-	Z	X	E	-	D
26	Y	Z	-	-	-	-	A	B
27	Z	-	Y	-	-	-	C	A
28	-	-	-	X	Y	D	E	-
29	-	X	-	Y	-	B	D	-
30	X	-	Z	-	-	A	-	C

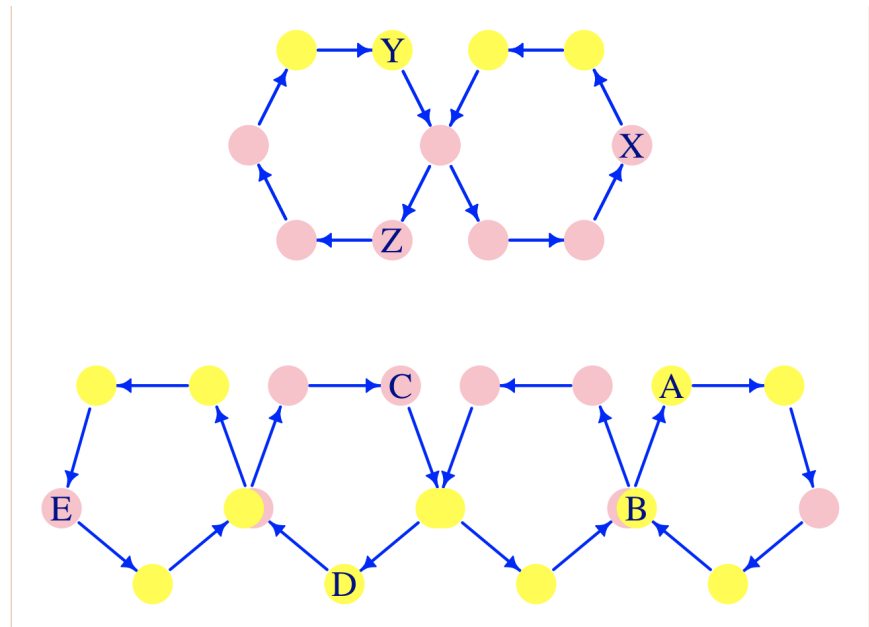

positions

Right-hand counting

Pattern by Melonhead

Variations: We've done two 7-person variations; in both the 5-weave is retained but the 3-weave is replaced by two 2-count feeders. In one the feeders are on the same side; the other is Twister style. To avoid a collision in the Twister, the feeders need to swap one of their throws on each cycle.

Two Mating Three Leaf Clovers

Refer to the 4-person Three Leaf Clover (standard). Make two copies that overlap along one leaf, and start out juggling within clover as normal. But whenever you and your enter the special leaf you transition into the other clover.

Chapter 9

9 Person Patterns

Feast

Everyone feeds everyone else, on count of your choice.

Big Hinge minus 3

Drop 3 of the 4 baby positions from this 12-person pattern.

Twister Sandwiches

Original Twister Sandwich

At first this is a difficult pattern, but it's awesome. You need 6 good weavers and 3 double-time twister weavers.

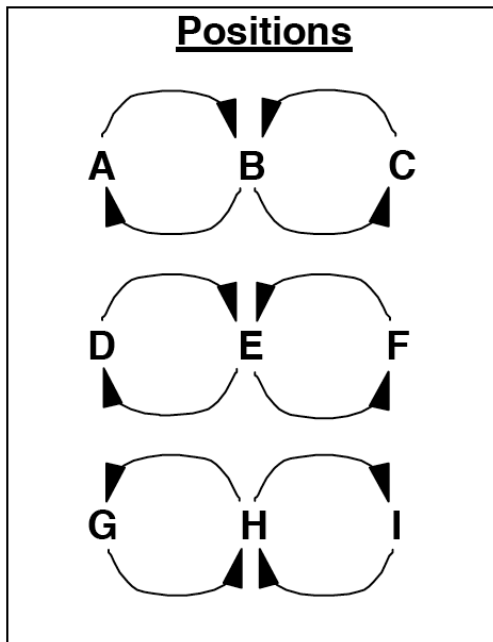

Juggler	1	2	3	4	5	6
A				F		
B		D			E	
C			F			E
D	A	B		I	H	
E		H	G		B	C
F	I		C	A		G
G			E			F
H		E			D	
I	F			D		

positions

Right-hand counting, or other

D, E, and F are doing the Double-time Twister Weave. The single feeders on the opposite sides of D, E, and F have been replaced with 3 weavers on one side and 3 weavers on the other side.

A, B, and C (and G,H, and I) are doing a standard weave; passing to D,E, and F.

To help you remember to whom you are supposed to pass, just pass straight across from whatever position that you are in. For example, C is in the right side, so when C passes, he or she will pass to who ever is in the right position at that time (in this case, C's first pass is to F). C will then move to the middle and pass to who ever is in the middle.

Twister Sandwich Variations

1. Replace either standard weave with one standard feeder or two every-other feeders. If there is one feeder, they are known as the Olive and the sandwich is an Open Faced Sandwich.
2. After one cycle, rotate the weaves by 90 degrees. For example, after one cycle the positions will be as indicated in the graph above. Run the next cycle with C, F, and I as one standard weave, B, E, and H as the double-time twister weave, and A,D, and G as a standard weave. This version is insane to implement, but it does provide intellectual stimulation.
3. Add another "slice" to the sandwich: add jugglers J, K, and L below G, H, and I. G, H, and I are also doing the Double-time Twister. This is the Double- Decker Sandwich.
4. If the outside weavers are having trouble keeping up, then you can change any of the weaves to fixed positions where the ends pass in 8-count and the insides pass in 4-count. This is known as Stale Bread.

In the parlance of stacked patterns, the (original) Twister Sandwich is a 3-3-3: weave; double-time-twister; weave.

Pattern by Peter Kaseman and MAJ.

Weaving Canoes

This pattern is a cross between the Asynchronous Double Weave and the Canoe. The Canoe for 3 jugglers is commonly referred to as a drop-back line. We recommend that you can do these before trying the Weaving Canoes.

<p style="margin: 0;"><u>Positions</u></p> <p style="margin: 10px 0 10px 20px;">A B C</p> <p style="margin: 10px 0 10px 20px;">D E F</p> <p style="margin: 10px 0 10px 20px;">G H I</p>	<table style="border-collapse: collapse; margin: 0 auto;"> <thead> <tr style="border-top: 1px solid black; border-bottom: 1px solid black;"> <th style="padding: 2px 10px;">Juggler</th> <th style="padding: 2px 10px;">1</th> <th style="padding: 2px 10px;">2</th> <th style="padding: 2px 10px;">3</th> </tr> </thead> <tbody> <tr><td style="padding: 2px 10px;">A</td><td style="padding: 2px 10px;">D</td><td style="padding: 2px 10px;"></td><td style="padding: 2px 10px;"></td></tr> <tr><td style="padding: 2px 10px;">B</td><td style="padding: 2px 10px;"></td><td style="padding: 2px 10px;">E</td><td style="padding: 2px 10px;"></td></tr> <tr><td style="padding: 2px 10px;">C</td><td style="padding: 2px 10px;"></td><td style="padding: 2px 10px;"></td><td style="padding: 2px 10px;">F</td></tr> <tr><td style="padding: 2px 10px;">D</td><td style="padding: 2px 10px;">G</td><td style="padding: 2px 10px;"></td><td style="padding: 2px 10px;"></td></tr> <tr><td style="padding: 2px 10px;">E</td><td style="padding: 2px 10px;"></td><td style="padding: 2px 10px;">H</td><td style="padding: 2px 10px;"></td></tr> <tr><td style="padding: 2px 10px;">F</td><td style="padding: 2px 10px;"></td><td style="padding: 2px 10px;"></td><td style="padding: 2px 10px;">I</td></tr> <tr><td style="padding: 2px 10px;">G</td><td style="padding: 2px 10px;">A</td><td style="padding: 2px 10px;"></td><td style="padding: 2px 10px;"></td></tr> <tr><td style="padding: 2px 10px;">H</td><td style="padding: 2px 10px;"></td><td style="padding: 2px 10px;">B</td><td style="padding: 2px 10px;"></td></tr> <tr style="border-bottom: 1px solid black;"><td style="padding: 2px 10px;">I</td><td style="padding: 2px 10px;"></td><td style="padding: 2px 10px;"></td><td style="padding: 2px 10px;">C</td></tr> </tbody> </table>	Juggler	1	2	3	A	D			B		E		C			F	D	G			E		H		F			I	G	A			H		B		I			C
Juggler	1	2	3																																						
A	D																																								
B		E																																							
C			F																																						
D	G																																								
E		H																																							
F			I																																						
G	A																																								
H		B																																							
I			C																																						

positions

- Right hand counting
- A, B, and C face downward. The rest face upward.
- Weavers are in rows. Canoes are in columns.
- D, E, and F pass drop-backs.

A, D, and G start the pattern with the first pass as indicated in the passing graph above. After they pass, they move to the right of their respective weaves. Meanwhile, B, E, and H make their first pass on the second passing beat, and then weave to the left, replacing A, D, and G. C, F, and I pass on the 3rd passing beat and weave to the left.

Variation: Have one of the weaving teams remain stationary.

Pattern dates to September, 1999 by Peter Kaseman.

Weaving Triangles

Here passes happen in the middle positions of the weave, in a Gandini-style.

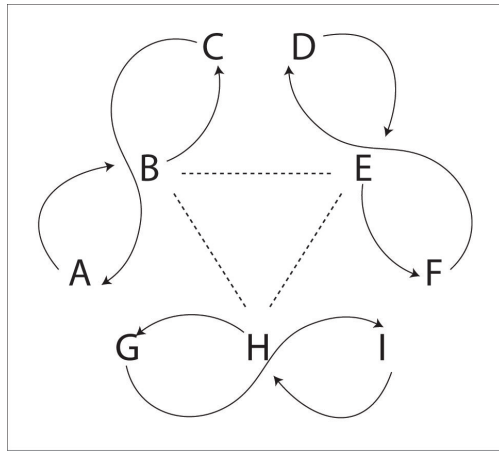

positions

Juggler	1	2	3	4	5	6
A					I	D
B	H	E				
C			G	F		
D					A	I
E	B	H				
F			C	G		
G			F	C		
H	E	B				
I					D	A

Right-hand counting

Try it with inside outside triangle first then inside triangle.

Pattern by Luke Emery.

Triangle of Weaves

Place three in-sync weaves on edges of an equilateral triangle, a bit like the Weaving Triangles pattern above, but each is an ordinary 6-count weave. On the inside throws the middle jugglers exchange on a triangle (pick inside or outside). Do the same for the outside throws. Cool!

This is different from the big weave variations in Chapter 11.

Stacks

1-2-3-2-1

This is a beautiful pattern on a 3-count base:

3-count olive; spinning 3-count pair; 4-5 twister; spinning 3-count pair; 3-count olive

It's nice and easy if you shift it to 4-count base. Then it's an ordinary twister in the middle, spinning 4-count pairs, and 4-count olives.

1-3-4-1

3-count olive; 4-5 twister; spiral weave; 3-count olive

Chapter 10

10 Person Patterns

Feast

With this many jugglers the feast naturally oscillates (to keep the passing distances about the same) and looks something like an Amoeba. Fun to make the group move across the floor while juggling!

5 on 5 lines

Pass to two opposites, say on 4 count, with two end jugglers on slower (e.g 8) count. Start one special (e.g. differently colored) club on one end and see if you can make it move to the other end!

Double-vision 5's

Take any 5-person pattern (well maybe not any one) and turn each juggler into two jugglers. E.g. try double-vision star!

Big Hinge minus 2

Take the 12-person big hinge and drop two of the baby positions, either line centers on two lines, or one line center and the matching feeder, as described here:

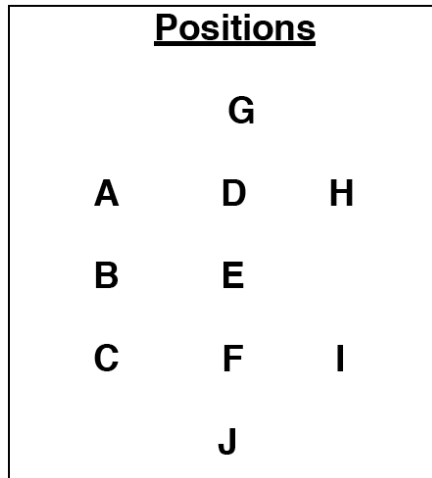

Juggler	1	2	3	4
A	E		G	
B		E		E
C	J		E	
D		G		G
E	A	B	C	B
F		J		J
G	H	D	A	D
H	G			
I			J	
J	C	F	I	F

Right-hand counting
Hinges: A, C
Feeders: E, G, J

Double Weave (with 10 jugglers)

This one is fun and pretty easy. Each juggler has just one counterpart in the other weave, and only passes the that juggler, on a fixed (usually 10) count.

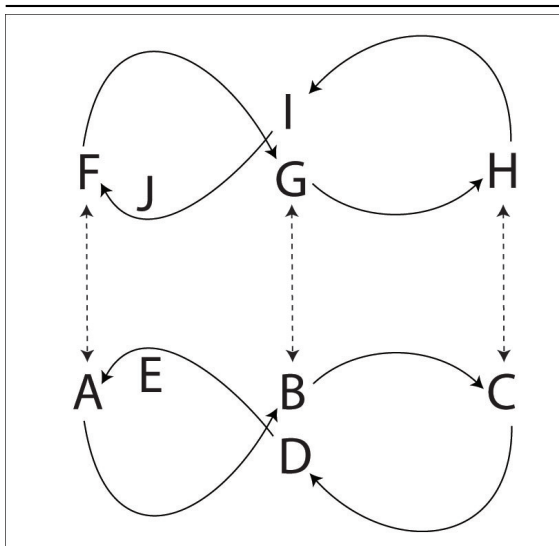

positions

Juggler	1	2	3	4	5
A	F				
B		G			
C			H		
D				I	
E					J
F	A				
G		B			
H			C		
I				D	
J					E

Right-hand counting, or other

Pattern by MAJ.

Double Gandini 5 Weave

Two mirrored Gandini 5 Weaves face each other and pass in 2-count (or any other count).

On either side weavers alternate directions as they leave the middle. It is easiest if weaver counterparts go the same direction (for example A and F start to the pattern's right and B and G start to the pattern's left).

Juggler	1	2	3	4	5
A	F				
B		G			
C			H		
D				I	
E					J
F	A				
G		B			
H			C		
I				D	
J					E

positions
Right-hand counting, or other

If this is too fast, then pass twice in the middle (either to the same weaver or to two different feeders).
 Pattern by MAJ and Gandini Juggling Project.

Double Blast

The Double Blast is two mirrored Blast patterns. It is easy.

Juggler	1	2	3	4	5
A		H		I	
B	G			J	
C		J			F
D	I		F		
E			G		H
F			D		C
G	B		E	B	
H		A			E
I	D			A	
J		C			

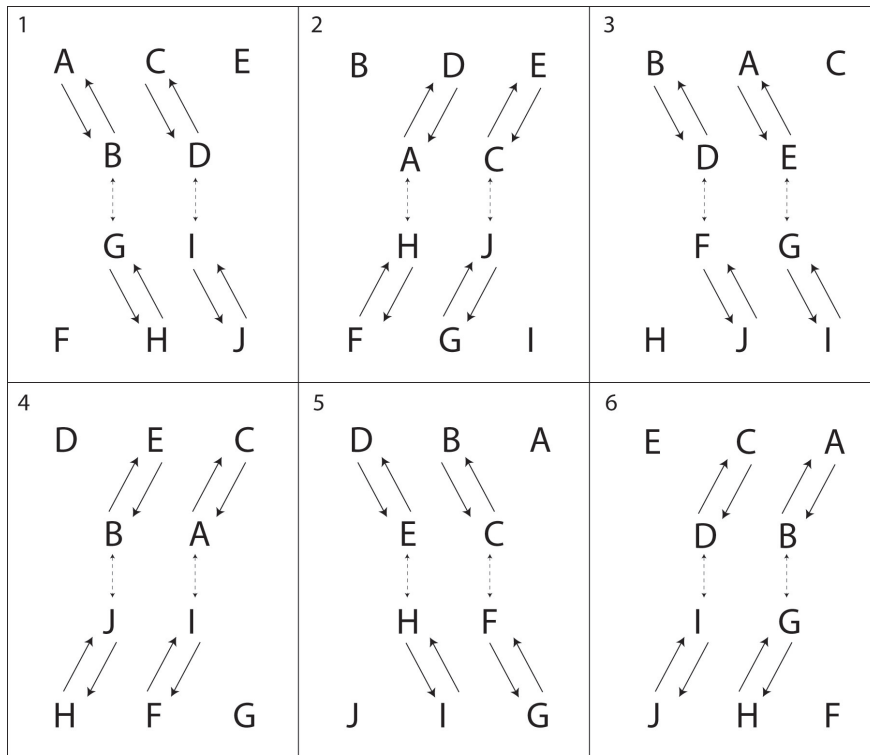

Pattern by Peter Kaseman and MAJ.

Two Mating Four Leaf Clovers

Refer to the standard 5-person 4-leaf clover, and duplicate for 10 jugglers. Overlap the clovers on one leaf, as indicated in the figure. Juggle as in a standard clover but when you and your double land in the overlapping leaf you change places, and thus move into the other clover.

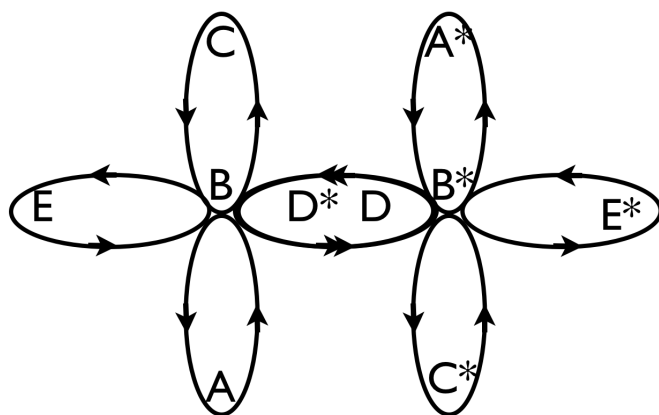

By Melonhead.

Chapter 11

Big Patterns

So the big problem with big patterns is to get enough interested jugglers who are like-minded and sufficiently skilled to pull off something cool. Mathematically there are many more possible juggling patterns for lots of people, but in fact most of them are not realistic, thanks to the big problem. We have been fortunate to overcome this problem in a few cases, summarized here.

Big Hinge

This one was an early big pattern, possibly done first in the Great Hall. Each side of a square is a line of 3 feedees. The feeders alternate being inside or outside of the square. The 4 corners (hinges) each participate in two lines.

<div style="border: 1px solid black; padding: 20px; width: fit-content; margin: 0 auto;"> <table style="border-collapse: collapse; text-align: center; font-family: monospace;"> <tr><td></td><td>B</td><td>E</td><td>I</td><td></td></tr> <tr><td>A</td><td>C</td><td>F</td><td>J</td><td>L</td></tr> <tr><td></td><td>D</td><td>H</td><td>K</td><td></td></tr> </table> </div> <p style="margin-top: 5px;">positions</p>		B	E	I		A	C	F	J	L		D	H	K		<table style="border-collapse: collapse; text-align: center; font-family: monospace;"> <thead> <tr style="border-top: 1px solid black; border-bottom: 1px solid black;"> <th style="border-right: 1px solid black; padding: 5px;">Juggler</th> <th style="padding: 5px;">1</th> <th style="padding: 5px;">2</th> <th style="padding: 5px;">3</th> <th style="padding: 5px;">4</th> </tr> </thead> <tbody> <tr><td style="border-right: 1px solid black; padding: 5px;">A</td><td style="padding: 5px;">B</td><td style="padding: 5px;">C</td><td style="padding: 5px;">D</td><td style="padding: 5px;">C</td></tr> <tr><td style="border-right: 1px solid black; padding: 5px;">B</td><td style="padding: 5px;">A</td><td style="padding: 5px;"></td><td style="padding: 5px;">F</td><td style="padding: 5px;"></td></tr> <tr><td style="border-right: 1px solid black; padding: 5px;">C</td><td style="padding: 5px;"></td><td style="padding: 5px;">A</td><td style="padding: 5px;"></td><td style="padding: 5px;">A</td></tr> <tr><td style="border-right: 1px solid black; padding: 5px;">D</td><td style="padding: 5px;">G</td><td style="padding: 5px;"></td><td style="padding: 5px;">A</td><td style="padding: 5px;"></td></tr> <tr><td style="border-right: 1px solid black; padding: 5px;">E</td><td style="padding: 5px;"></td><td style="padding: 5px;">F</td><td style="padding: 5px;"></td><td style="padding: 5px;">F</td></tr> <tr><td style="border-right: 1px solid black; padding: 5px;">F</td><td style="padding: 5px;">I</td><td style="padding: 5px;">E</td><td style="padding: 5px;">B</td><td style="padding: 5px;">E</td></tr> <tr><td style="border-right: 1px solid black; padding: 5px;">G</td><td style="padding: 5px;">D</td><td style="padding: 5px;">H</td><td style="padding: 5px;">K</td><td style="padding: 5px;">H</td></tr> <tr><td style="border-right: 1px solid black; padding: 5px;">H</td><td style="padding: 5px;"></td><td style="padding: 5px;">G</td><td style="padding: 5px;"></td><td style="padding: 5px;">G</td></tr> <tr><td style="border-right: 1px solid black; padding: 5px;">I</td><td style="padding: 5px;">F</td><td style="padding: 5px;"></td><td style="padding: 5px;">L</td><td style="padding: 5px;"></td></tr> <tr><td style="border-right: 1px solid black; padding: 5px;">J</td><td style="padding: 5px;"></td><td style="padding: 5px;">L</td><td style="padding: 5px;"></td><td style="padding: 5px;">L</td></tr> <tr><td style="border-right: 1px solid black; padding: 5px;">K</td><td style="padding: 5px;">L</td><td style="padding: 5px;"></td><td style="padding: 5px;">G</td><td style="padding: 5px;"></td></tr> <tr style="border-bottom: 1px solid black;"><td style="border-right: 1px solid black; padding: 5px;">L</td><td style="padding: 5px;">K</td><td style="padding: 5px;">J</td><td style="padding: 5px;">I</td><td style="padding: 5px;">J</td></tr> </tbody> </table> <p style="margin-top: 5px;">Right-hand counting</p>	Juggler	1	2	3	4	A	B	C	D	C	B	A		F		C		A		A	D	G		A		E		F		F	F	I	E	B	E	G	D	H	K	H	H		G		G	I	F		L		J		L		L	K	L		G		L	K	J	I	J
	B	E	I																																																																														
A	C	F	J	L																																																																													
	D	H	K																																																																														
Juggler	1	2	3	4																																																																													
A	B	C	D	C																																																																													
B	A		F																																																																														
C		A		A																																																																													
D	G		A																																																																														
E		F		F																																																																													
F	I	E	B	E																																																																													
G	D	H	K	H																																																																													
H		G		G																																																																													
I	F		L																																																																														
J		L		L																																																																													
K	L		G																																																																														
L	K	J	I	J																																																																													

Hinges: B, D, I, K **Feeders:** A, F, G, L

Hinges are great patterns for large numbers of jugglers, but admittedly, that can be rather boring for more advanced passers. One solution is the Precious Metal Hinge.

Precious Metal Hinge

Any line of three can be escalated by adding one or more clubs to the feed. For example, in the 12 person hinge above, A can feed an extra club feed with doubles. In this case:

- **A** – Feeds B, C and D in standard 7 club extra club 2-count doubles feed.
- **B** – Hinge, throws doubles to A and singles to F in 4-count.
- **D** – Hinge throws doubles to A and singles to G in 4-count.
- **C** – Throws doubles to A in 4-count.

That’s a Golden Hinge. To start have B start with 4 clubs and A start with a left self).

For a Platinum Hinge, A throws triples and adds 2 clubs. B, C and D throw triple straight passes to A. B starts with a triple to A and A starts with a triple to C. C does a self.

For a Diamond Hinge (diamonds aren’t actually a precious metal, I know), there are 4 extra clubs in the line. A throws all triple right hand passes and B, C and D throw triple right hand selves except when they throw triples to A or singles to the other feeder.

You can mix and match precious metals on any side of the hinge, although care must be taken to keep the timing synchronized.

Double Vision Hex

See 6-person Hex and make each juggler two! Still a dream, but maybe not for long.

Fully Loaded Blast

The Blast has a lot of fun and challenging variations. Here’s a Blast loaded up with extra passes and twister weaving for 11 people, but the basic concept works for 7 through 12 people.

The movers (G, H, I, J, and K) move in a typical Blast fashion, except they turn around after every pass to A and B to pass to feeders behind the weave.

The table shows $\frac{1}{2}$ of a full cycle, so the table ends in the mirror image of the start.

Juggler	1	2	3	4	5	6	7	8	9	10
A	H		I		G		K		I	
B	J		K		H		J		G	
C	G		G		I		I		K	
D	I		H		K		G		J	
E	K		J		J		H		H	
F		G		J		I		H		K
G	C	F	C		A		D		B	
H	A		D		B		E	F	E	
I	D		A		C	F	C		A	
J	B		E	F	E		B		D	
K	E		B		D		A		C	F

- Right-hand counting.

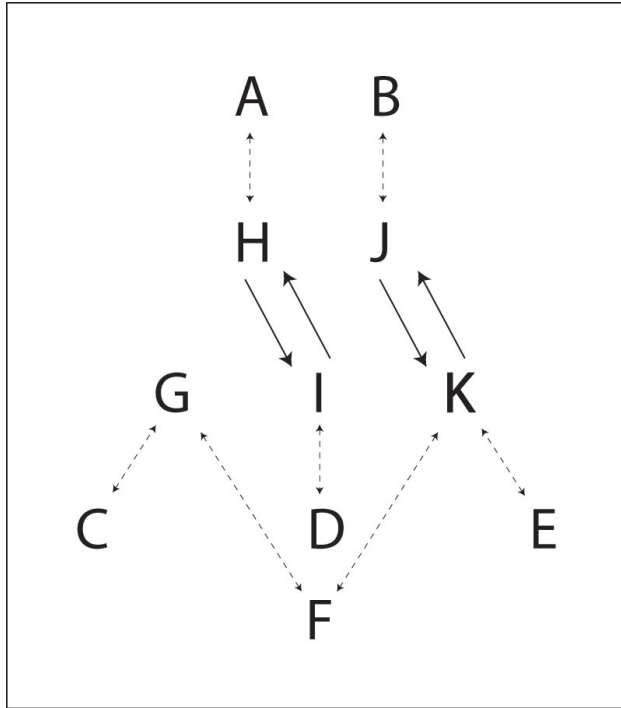

For more variations, replace D and F with a weave or with a single feeder. You can also remove either of the outside feeders C and E for fewer people (and an easier pattern).

Replacing D and F with a weave is called the Blast Toupee (because there is a weave on top).

Pattern by Peter Kaseman and MAJ.

Double-Decker Sandwich

A sandwich with two middle layers. In stacking speak, it's a 3-3-3-3: weave; double-time twister; double-time twister; weave.

Pattern by MAJ.

Triangle Weave

The Triangle Weave for 15 jugglers consists of 3 standard weaves (9 jugglers) and 6 feeders in 4-count. There is a Mr. Inside feeder for each weave, and then a Mr. Outside feeder in between the weaves who passes in turn to each adjacent weave.

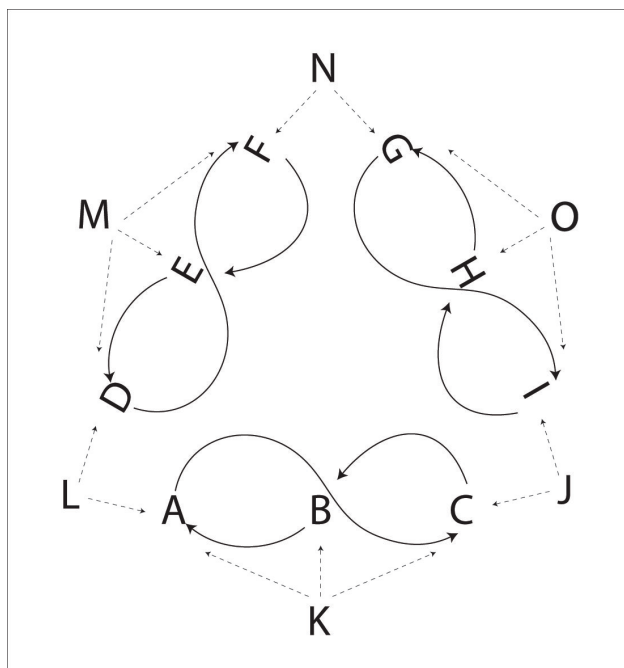

Juggler	1	2	3	4	5	6	7	8	9	10	11	12
A	L			K			J			K		
B		K			L			K			J	
C			J			K			L			K
D			L			M			N			M
E		M			N			M			L	
F	N			M			L			M		
G			N			O			J			O
H		O			J			O			N	
I	J			O			N			O		
J	I		C		H		A		G		B	
K		B		A		C		B		A		C
L	A		D		B		F		C		L	
M		E		F		D		E		F		D
N	F		G		E		I		D		H	
O		H		I		G		H		I		G

- Right-hand counting.

To start, all the Mr. Outside feeders pass to their right, and then feed alternately left and right in 4-count. The Mr. Inside feeders start on beat 2 and pass 4-count to their weave. The weavers pass to alternate Mr. Outside feeders on either end and the Mr. Inside feeder in the middle.

There are all the usual variations of different weave counts, chocolate bars, left handed etc. The pattern design can be any polygon where the side is a weave with a Mr. Inside feeder and the vertices of the polygon are a Mr. Outside feeder who alternates passing between weaves (also known as Doc Blanchard and Glenn Davis). See also the Octagon Weave. The number of jugglers is $5N$ were N is the number of sides of the polygon (three for each weave plus 2 feeders).

Pattern by Mike Newton and Luke Emery.

Octagon Weave

Similar to the Triangle Weave, except with 8 sides and 48 jugglers. This was the big pattern at 2007 Madfest.

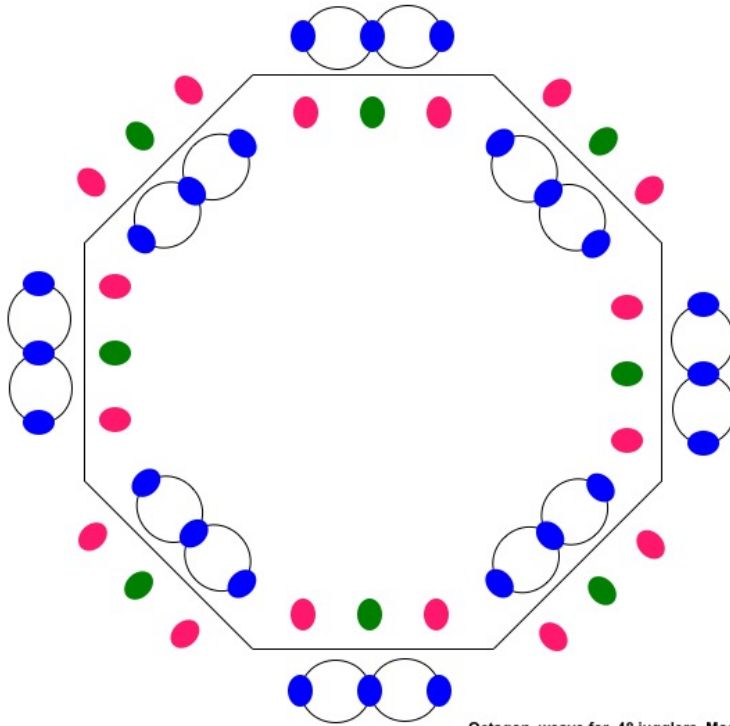

Octagon weave for 48 jugglers. Madfest 2007 by MAN

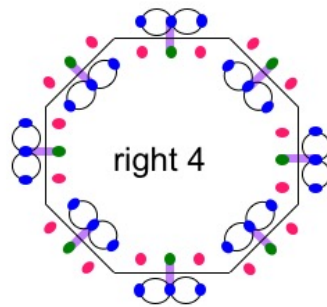
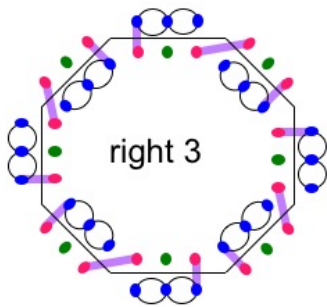
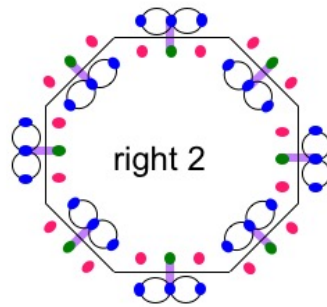
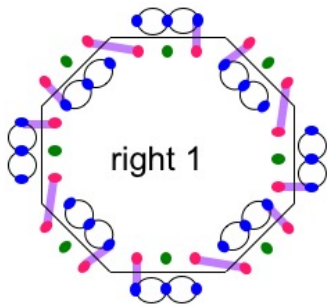

12 right hands for full cycle
 Variations: weavers inverted, preverted, or dresser drawer
 Doc Blanchard switches sides to create twister

Pattern by Mike Newton.

Mating Clovers

There are lots of interesting options by mating clovers and possibly adding orbiters. We got a Box of Four Leaf Clovers, for 20 jugglers, working at a recent Pass Out. We may do a Hex of Three Leaf Clovers (below), for 24 jugglers, at Madfest 2018. We've practiced a mate pair of 4 leaf clovers with 2 orbiters (12). Orbiters stay in their clovers; others move between clovers. The standard configuration has one juggler per isolated leaf; two jugglers per overlapping leaf, and one in the middle of each clover (e.g. on points of the hexagon below). Line up the start so that those sharing a leaf are counterparts in the two neighboring clovers.

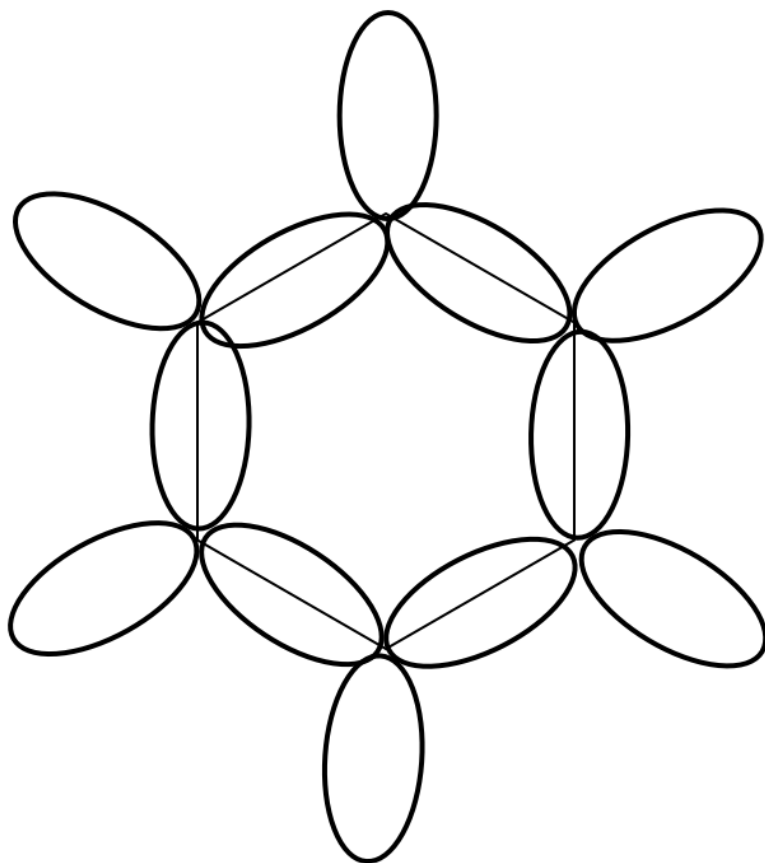

By Melonhead and MAJ.

Big Circle

▷ A moving juggler, moves clockwise in outer ring, counterclockwise in inner ring, passes in 8 count to non-moving juggler on their left

■ A non-moving juggler, passes in 4 count, alternates passing to the moving juggler to their right and the non-moving juggler straight ahead

There are two lanes of passing in this pattern, the blue line show the first lane

The pink lines show the second lane

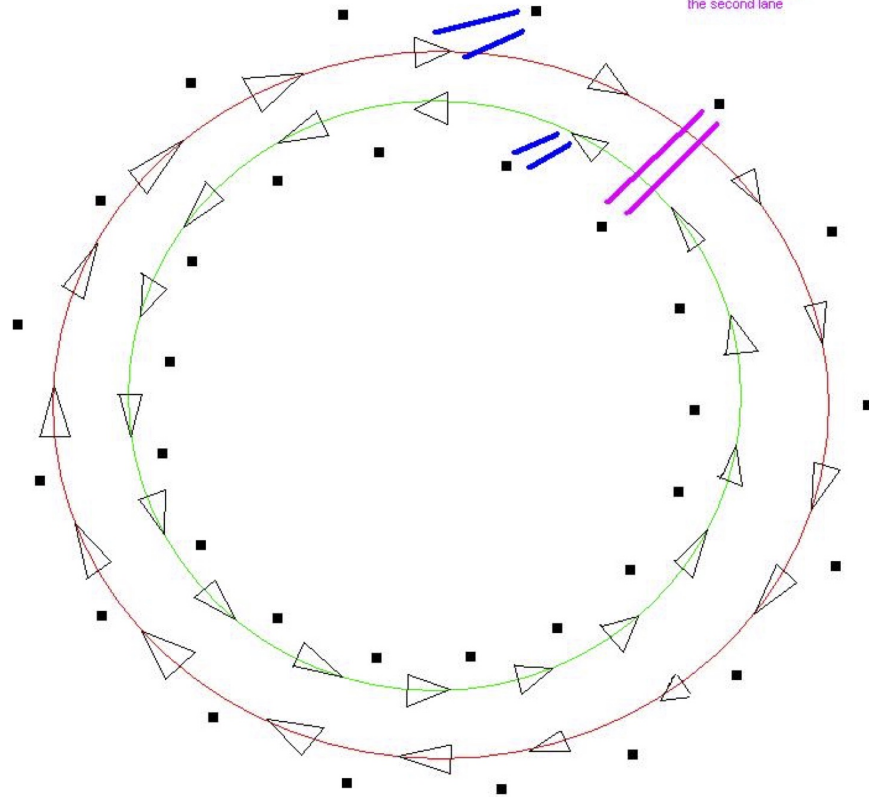

Pattern by Graham Paasch. Juggled at 2013 Madfest. Thanks Casey Rentmeester¹

¹https://youtu.be/hfRiGC7_NSU

Chapter 12

Luke's Extras Plus More from Graham

Dual Passing Patterns

Steve and Mike were playing with the idea of considering the hands of a juggling passing pattern independently of the jugglers, and then moving around which jugglers are attached to which hands. Between every two real jugglers is a phantom or shadow juggler whose left hand is a real person's right hand and their right hand is a different real person's left hand. Every pattern has a corresponding out of phase dual passing pattern.

We discovered a number of new 6 and 7 club patterns and multi person patterns we hadn't tried before. I sent out a bunch of 7 club siteswap passing patterns that come from known 7 club patterns. An interesting corollary is that for every asynchronous passing pattern (left, right, left, right) there is a corresponding synchronous passing pattern (where lefts and rights throw together). This is true for all passing patterns, but especially fun for 7 clubs where collisions aren't as problematic as with 6 club patterns. Some of these patterns are quite difficult, which explains why I don't think I've ever seen any 7 club synchronous patterns in practice except for the basic left double, right single pass.

Yesterday Peter and I worked out some of the "Pod" patterns for 7 club fast/slow variations. Instead of one juggler juggling 2 count against another juggler juggling 3 count, try right hands juggling 2 count against left hands juggling 3 count, etc.

El Nino with phantom jugglers is doable but difficult. The asynchronous 4 person box turns into a very nice and easy synchronous passing pattern (pass 2 to the left, then 2 to the right). Most of the 5 person star patterns turn into either themselves (like the self-less star) or another known 5 person pattern. There's no end in sight!

If 3 jugglers A, B, and C are standing in a triangle formation, define 3 virtual jugglers X, Y, and Z so that X is between A and B, Y is between B and C, and Z is between C and A.



A's left hand is X's right hand, and A's right hand is Z's left hand. Similarly, B's left hand is Y's right, B's right hand is X's left, C's left hand is Z's right, and C's right hand is Y's left.

Any pattern performed by A, B, and C has a dual pattern performed by X, Y, and Z. To generate a new pattern, pick any pattern for X, Y, and Z, and then find out what A, B, and C are doing. In the table below we have X feeding 2-count to Y and Z with the dual pattern for A, B, and C.

Juggler	1	2	3	4
X	R pass Y	L self	R pass Z	L self
Y	R pass X	L self	R self	L self
Z	R self	L self.	R pass X	L self
A	L pass C	R pass C	L self	R pass C
B	L self	R pass A	L pass C	R pass A
C	L pass A	R pass B	L pass B	R pass B

Both hands counting

The idea of dual passing patterns was conceived by Mike Newton and Steve Otteson in 2001 and applied to many passing patterns by the MAJ.

Dual Passing Pattern for 4

Four jugglers A, B, C, and D stand in a box formation and the virtual jugglers W, X, Y, and Z do a pass-pass-self-self (chocolate bar) box pattern. The dual pattern for A, B, C, and D is shown below. A and C start with 4 clubs each. B and D start with 2 clubs each.

A	W	B
Z		X
D	Y	C

Juggler	1	2	3	4
W	R pass Y	L self	R self	L pass Y
X	L self	R pass Z	L pass Z	R self
Y	R pass W	L self	R self	L pass W
Z	L self	R pass X	L pass X	R self
A	R,L pass D		R, L pass B	
B		R, L pass A		R, L pass C
C	R, L pass B		R, L pass D	
D		R, L pass C		R, L pass A

The A, B, C and D square is now doing a synchronous pattern, where the right and left hands throw at the same time.

Dual passing is a good tool for discovering synchronous patterns.

Notice that if beats 1 and 2 are repeated, then W, X, Y, and Z will be doing a 2-count box with right hand

passes. If beats 3 and 4 are repeated, then W, X, Y, and Z will be doing a 2-count box with left hand passes. This pattern was generated by the Madison Area Jugglers March 3, 2001, and was the first dual pattern created.

Dual Passing Pattern for 2

This pattern is for 2 jugglers A and B. The virtual jugglers Y and Z do a 7-club 3-count pattern.

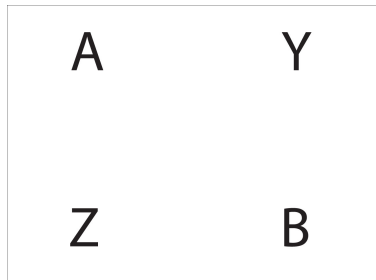

Juggler	1	2	3	4	5	6
Y	L self	R D-Z	L self	R self	L D-Z	R self
Z	L D-Y cross	R self	L self	R D-Y cross	L self	R self
A	R D-B cross	L T-self	R B	L S-B	R B	L B
B	R S-A	L S-A	R A	L D-A cross	R T-self	L A

Notice the triple self throw for A and B. We found that the triple spin gave us the time needed to make the pattern work for us.

The pattern for A reads: Right double pass to B crossing (right to right), Left to Right triple self, right single straight pass to B, left single straight pass to B, right single straight pass to B, left single straight pass to B.

In (one form of) pass siteswap notation, you could right that as 4px53p3p3p3p.

The dual pattern for 7-club 3-count was created by the Madison Area Jugglers March 3, 2001.

Gandini Siteswap Weaves

Site-swap is a way to use numbers to determine how high an object is thrown in a pattern, and determines which hand the object lands in. At the IJA festival in Niagara Falls, Sean Gandini showed us that jugglers could weave in a site-swap pattern while being fed passes by a feeder.

Take any valid site-swap string, 741, for example, and find the average: $7 + 4 + 1 = 12$, $12/3 = 4$. The average of the site-swap string is the number of weavers needed for the pattern. Add one more juggler to feed the weavers and we are ready to go.

The feeder will alternately feed passes to 2 positions. The site-swap numbers will guarantee that only one weaver will be in a feeding spot when it is time to feed that spot a pass. Arrange the weavers so that the start will work. See the example below to see how this is done.

Have the feeder assign the site-swap numbers at the same time that the passes are made, repeating the numbers as they go. When a weaver receives a pass he or she will also receive a number. The number, minus one, is the number of self throws that the weaver will perform before he or she will make the next pass to the feeder. If the given number is even, then the weaver will get his or her next pass at the same feeding spot

where the last pass was received. If the given number is odd, then the weaver has to cross over to the other feeding spot for the next pass.

To save space, the feeder is not pictured in the following example.

741 Site-Swap Weave

Lines indicate passes, arrows indicate movement.

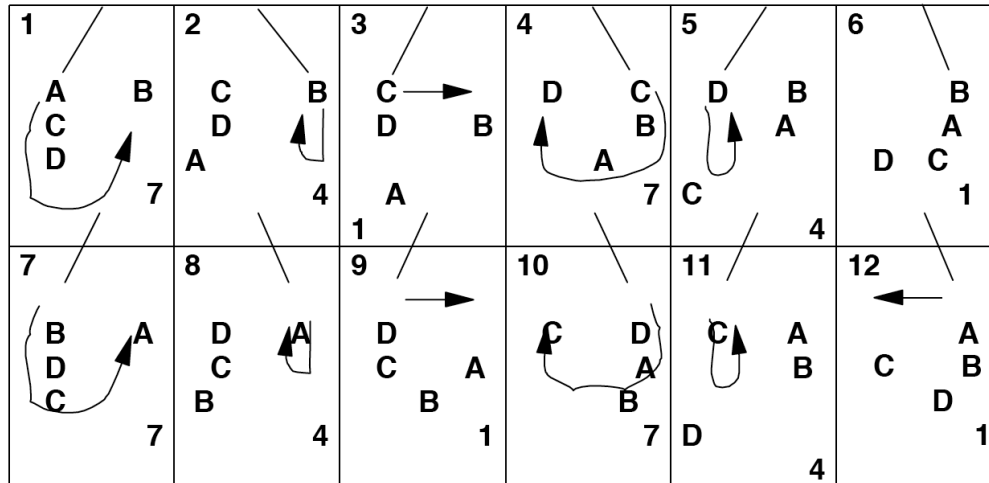

This idea can be extended in many different ways. For example, the weavers and feeders can do patterns like Burke's Barrage or Mill's Mess. A double weave can be any two siteswap weaves passing to each other. For example, try a regular Gandini Weave (333) against a 441 Gandini Weave or a 534 Gandini weave, etc.

7 Club Patterns

Peter Kaseman and I had an experiment in winter 1999 to think up how many 7 club patterns we could do. The goal was 100, and at first we thought that would be a difficult target. However we soon realized that there are so many possible site swap variations and tempo changes to easily pass 100. Not of all of them are easy to actually juggle though! Here are a few of them.

Chocolate Bars

4p4p33 | 3p3p44

A: crossing double pass right, crossing double pass left, self, self.

B: straight single pass right, straight single pass left, straight double self, straight double self (starts with 4)

4p4p33 | 3px3px33

A: straight double pass right, straight double pass left, self, self.

B: crossing single pass left, crossing single pass left, straight double self, straight double self (starts with 4)

4p4p33 | 33px5px3

A: straight double pass right, straight double pass left, self, self.

B: self, crossing single pass right, crossing triple pass left, self

4px4px33 | 33p5p3

A: crossing double right, crossing double left, self, self.

B: right self, straight single pass left, straight triple pass right, self, self.

4-count variations

Here's a nice variation on 4-count triples in 7.

5p333533p3 | 335p33533p

In right hand counting: triple pass, single self, triple self, single pass.

Pass, Pass, Shuffle

5px5px1 | 4p4p1 (2nd juggler starts on beat 2)

A: triple cross, triple cross, shuffle.

B: pause, double straight, triple cross, shuffle.

Another 6-count

5p33334 | 3345p33

Crossing triple right, self, self, self, self, straight self double left

Paired Siteswap Passing Patterns

Any two siteswaps can be turned into passing patterns. For example, consider the 4 club siteswap 534 and the trivial 3 club siteswap 333. There are 12 different passing patterns from combining these two siteswaps. The juggler with the 534 can pass the 5, or the 3, or the 4, or the 5 and 3, 5 and 4, 4 and 3 or all of them. The juggler juggling the 3's just has to throw 1, 2 or 3 passes to match the timing of the first juggler. Then, we can switch all the straights to crosses and the crosses to straights to generate 6 more patterns (although 3 of them don't actually work because the two 3's collide if they are both crossing).

5p34 | 333p

53p4 | 33p3

534p | 3p33 (second juggler starts with 4)

5p3p4 | 33p3p

5p34p | 3p33p (second juggler starts with 4)

5p3p4p | 3p3p3p (second juggler starts with 4)

Crossing versions that work include:

5px34 | 333px

534px | 3px33 (second juggler starts with 4)

5px34px | 3px33px (second juggler starts with 4)

The same idea can be extended to any set of siteswaps with any number of items, such as 561 against 531 or 7441 against 7531. The simple siteswap 444 | 333 has a lot of nice passing variations. More complex siteswaps get challenging very quickly, though.

If the two jugglers have different numbers of clubs (for example 444 | 333), then they can switch sides with each other at almost any point by the first juggler throwing two passes in a row.

There is also a dual passing pattern variation of each of the above, as described earlier.

Popcorns

4-count: 3p353 | 533p3

5-count: 3.5p 3353 | 53 3.5p 33 (slight pause for 2nd juggler)

6-count: 4p33353 | 3534p33 (juggler 2 starts with left on these 6-count popcorn)

or 4p33344 | 3444p33 or 4p44144 | 1444p44 (skip 1 on start)

or 4p53153 | 1534p553 (skip 1 on start)

7-count: 4.5p 333353 | 353 4.5p 333

All even counted popcorns can also be juggled left-handed or with all crossing passes (one juggler left handed and the other right handed).

Now, to make things more interesting, all the popcorns can be juggled against either the next or previous versions in fast/slow. One juggler juggles fast, and the other slowly, so that they each complete a cycle at the same time. The odd count juggler always throws to the same side with alternating left and right passes (also alternating straight and cross passes). The even count juggler throws to each side in turn, also alternating straight and cross passes.

Try 7 club 1-count against 2-count, 2-count against 3-count, 3-count against 4-count, 4-count against 5-count, 5-count against 6-count and 6-count against 7-count.

All of the above patterns have Dual Passing Pattern variations, which tend to have a lot of ultimate single passes and some challenging synchronous variations. Try some and see.

4px5p3p4px5p3px | 3p3p3p3p3p3p (2nd juggler starts with 4)

4px33p3p4px4px | 3p4px4px4px33p (2nd juggler starts with 4)

4px33p3p | 3p4px53p

Three Up

Three Up is a 7 club 8 count popcorn pattern based on the 5551 siteswap with 4 clubs that Peter brought back from somewhere. As an incoming pass comes in, flash 3 crossing doubles (555), catch the incoming club, shuffle it from left to right and then pass it back as a single pass.

55513p333 | 3p333551

It's technically possible to juggle this pattern with 8 clubs as 55514px | 4p5551 (the fives are doubles and the four is a single) but that's tough.

The 7-club version is more reasonable, and allows opportunity to play with all kinds of 4 club siteswaps. Try replacing the 5551 with 7441, 6631, 7531 and 5641.

7 Club 2-Count Exposed

Seven clubs is the playground for the serious club passer. Six clubs is easy. Eight is hard. Seven is just right.

So you know 7 club 2-count? That's great! But, wait, do you really? Let's take a closer look.

The standard 7 club 2-count consists of right handed passes as doubles and left handed single spin selves.

1. 4p3 | 34p

This pattern can of course be done with left handed passes too.

1. 34p | 4p3 left handed

By changing the height of the throws, the pattern can also be done with single spins.

1. 3.5p 3.5 | 3.5p 3.5
2. 3.5 3.5p | 3.5 3.5 left handed

Now, speaking of spins, all kinds of spin combinations are possible. One juggler can throw doubles while the other throws singles, or triples versus doubles. Even though the patterns are quite doable, that makes the timing a bit wonky. However, if one juggler throws triples while the other throws singles, then the timing locks in to a new simple siteswap. (Have the juggler passing single passes start with 4 and juggle with their right hands in sync with the juggler throwing triple passes.)

1. 5p3 | 3p3
2. 35p | 33p left handed

It's a curious and useful fact that any 7 club passing pattern can be modified by changing all the straight passes to crosses and all the cross passes to straights. This is actually applicable to all passing patterns, but for 6 and 8 club passing patterns many such variations lead to collision problems. For 7 club passing, however, a majority of the crossed patterns still work.

Each of the patterns we've discussed so far can also be juggled in a crossed version, where both jugglers cross passes. This means that one juggler will be making left hand passes (in 2-count) and the partner will be making right hand passes.

Crossed versions of above.

1. Crossed version of doubles 2-count, both right and left handed: 4px3 | 34p.
2. Crossed version of singles 2-count, both right and left handed: 3.5px 3.5 | 3.5 3.5px.
3. Crossed version of triple/singles 2-count, both right and left handed: 5px3 | 3px3.

Because of symmetry, there are really only 9 unique patterns so far instead of 12. The left hand versions and the right hand versions turn into the same pattern when the jugglers cross passes.

As we've seen, every passing pattern has a corresponding complementary dual pattern (or shadow pattern) where a juggler's right hand pattern is combined with the left hand pattern of the adjacent juggler. This is really just one permutation of a 4 person 2 handed site swap. Each of the 9 patterns above has a corresponding shadow person pattern, and curiously, they are all 2-count, more or less. Let's look at a couple more closely.

1. The shadow pattern for the standard 4p3 is a synchronous juggling pattern where the left and right hands of a juggler throw and catch at exactly the same time. For this pattern the left hand will throw a crossing double self while the right hand throws a straight single pass: (4x, 3p) | (4x, 3p). The second juggler pauses $\frac{1}{2}$ beat before throwing their 2 synchronous throws: one as a pass and the other as a self.
2. The same pattern can be done left handed (3p, 4x) | (3p, 4x).
3. If we change all the straight passes to crosses, then both 10 and 11 transform into the same pattern: (3px, 4x) | (4x, 3px).

The synchronous versions are very interesting 7 club 2-count patterns in their own right, and are a great foundation for exploring other synchronous patterns. You can switch back and forth from left handed to right handed throws (still in 2-count, sort of) to make a fantastic 7 club pattern. One juggler will need to throw crosses while the other throws straights.

1. Switching sync throws. (4x, 3px) (3px, 4x) | (3p, 4x) (4x, 3p).

This is in the same family as Will Murray's fantastic 7 club Scratch Your Head pattern, which is the same except the double self crosses and straights are switched.

1. Scratch Your Head. (4, 3px) (3px, 4) | (4, 3p) (3p, 4).

That's still kind of a 2-count pattern!

The single spin version of seven 2-count doesn't change when you look at the associated dual pattern (7 1-count singles is the same way).

However, the triples/singles version makes an interesting set of dual pattern variations, still in 2-count!

1. Fast lop-sided popcorn: 53p | 33p.
2. Of course it can be done left handed: 3p5 | 3p3.
3. And theoretically, with crossing passes: 53px | 33px. This one doesn't work too well, because there is a collision problem with the 2 crossing singles.
4. And 20 again, with left hand self triples: 3px5 | 3px3. This one doesn't work very well either because of collisions.

Had enough? Well, there are more where those come from. Next, we look at combinations where one side does a synchronous pattern and the other does an asynchronous pattern. These are handy patterns when one juggler wants to try synchronous variations, but the other passer isn't ready for that yet.

1. Here's the simplest: (3p, 4x) | 4p3.
2. Now left handed: (4x, 3p) | 4p3 left handed.
3. And, or course, crossing right handed: (3px, 4x) | 4px3.
4. And crossing left handed: (4x, 3px) | 4px3 left handed.

Now try some variations where the extra clubs and synchronization are both on one side. They are asymmetric 2-counts, but that can be good if you have a mixture of passing skill levels.

1. One juggler throwing both doubles synced (4p, 4x) | 3p3.
2. And left handed (4x, 4p) | 33p.
3. And crossing (4x, 4px) | 3px3.
4. And crossing left handed (4px, 4x) | 33px.

There's a good start, but there are many many more without leaving 7 clubs with only doubles and single passes. Try some of these variations next time your passing partners says they're bored with 7 club 2-count.

So you know 7 club popcorn? That's great! But wait... do you really...?

Synchronous Passing

Hi Mandy,

Here is the 8 club version of the 7 club sync passing pattern I showed you and Will at Millstreet. I'm not quite ready for the 8 version at the moment, but I think it will be a very beautiful pattern and I look

forward to seeing you show it to me next time we're at a convention together!

Luke

A B

A starts with 5 clubs (3 in right, 2 in left), B with 3 (2 in right, 1 in left). Every throw is a pass and each passer has their left and right throws synchronized. Here's the text description rather than the siteswap.

A throws synchronized right triple straight, left single cross

B responds $\frac{1}{2}$ beat later

B throws synchronized right single straight, left triple cross

A throws synchronized right single cross, left triple straight

B throws synchronized right triple cross, left single straight

Repeat until you get bored. :)

Interestingly enough, 3 clubs always do singles and 5 clubs always do triples, which might make color coordinating the clubs useful.

Technically it seems to work out to be 5 club 1 count with triples synchronized with a 3 club 1 count as singles.

A number of people wrote to ask me about the 7 club version of that 8 club sync pattern, which I probably should have just included. Anyway, here it is, as well as some others.

The first juggler has the same sequence, while the second responds in synchronous ultimate singles.

A B

A starts with 4 clubs (2 in right, 2 in left), B with 3 (2 in right, 1 in left). Every throw is a pass and each passer has their left and right throws synchronized.

A throws synchronized right triple straight, left single crossing

B responds $\frac{1}{2}$ beat later

B throws synchronized right single straight, left single straight

A throws synchronized right single crossing, left triple straight

B throws synchronized right single straight, left single straight

I haven't actually tried the 8 club version myself yet, but the 7 club version is challenging enough. Although one side just throws singles, they have to catch a triple and a single pass at the same time on every beat, and that can be tricky... at least for me. As a variation, it

should also work for A to throw the other side of the 8 pattern with crossing triples and straight singles. B would do the same as before, except B would then start with 2 in the left hand and 1 in the right.

If you are interested in 7 club synchronous passing patterns, here are some easier ones to start with.

A B

One sync pattern is just 7 club 3 count in all single spins, which has an interesting, if choppy, sync rhythm.

Basic 7 club synchronous right handed:

A throws synchronous left hand crossing double self, right hand straight single pass.

B responds 1/2 beat later with the same.

Repeat.

Of course, you can do the same pattern with left handed passes and right double selves.

Then, if you're feeling up to it, you can switch back and forth from left handed to right handed sync passing on each cycle to make another fun but challenging pattern, as follows:

A right pass single straight, left self double crossing

B (responds with) right pass single straight, left self double straight

A right self double crossing, left pass single straight

B right self double straight, left pass single straight

I came up with that quite a few years ago when I (with Peter) worked out a list of 100 passing patterns for 7 clubs. It is somewhat similar to Will and Rhonda's Scratch Your Head pattern, which I had never seen, (though I heard rumors about it), until I tried it for the first time in

Millstreet. For some reason it seems to me that the synced crossing self doubles are easier than the synced straight self doubles.

I believe Will already has a good description of the synchronous Scratch Your Head pattern somewhere else, but here it is anyway:

A right pass single straight, left self double straight

B (responds with) right pass single crossing, left self double straight

A right self double straight, left pass single straight

B right self double straight, left pass single crossing

It's nice and I'd like to get the Scratch Your Head pattern down solid now that I've learned how to do it, so I'm planning to work on that here.

Hmmm, the thought occurs to me that you may be able to switch back and forth between Scratch Your Head and the previous pattern (which I think needs a name...) at any time, just by throwing a cross single pass and straight double self instead of a cross double self and straight single pass.

Also, I just noticed that Scratch Your Head has a similar quality to the 8 club sync pattern, in that 4 clubs always do doubles and 3 clubs always do singles. It's a 4 club pattern (all self straight doubles, site swap 4) superimposed on 3 club 1 count instead of a site swap 5 superimposed on a 3. They're sister patterns!

Very cool.

Anyway, I hope that's interesting to anyone who likes 7 club sync passing...

Passing 43

Here is a further analysis of all the possible 2 person 7 club patterns in the siteswap 43. There appear to be 58 valid patterns.

Within each group of related patterns, you can switch between patterns of the same group at any time. You can switch between the 2 synchronous patterns or between the 2 asynchronous patterns with no effort, but to switch from async to sync requires one of the usual site swap sequences. For example, in standard 7 club 2-count doubles you can switch from 4p 3 to 3px 4 (start with the 4) or switch between (4px 4) and (4x 4p) synced.

Of course there are also site swaps to go between groups. To get from the RL group to the LR group, just change a straight pass to a crossing pass (or vice versa), and both jugglers exchange groups with each other.

To go from right handed patterns to left handed patterns (such as RR to LL) is a little trickier; you need a siteswap like $4p\ 4p\ 2\ | \ 3\ 4p\ 4p$.

To go from RR to RL requires one juggler to switch left and right timing completely, with a throw like $(4x, 2)$ and a siteswap from their partner that give them enough time to do that (such as an early triple or an extra 4).

Each pattern belongs to a group and requires a partner match from a group. For example, there are 4 patterns in the RR group and each of those patterns requires a partner also in the RR group. That means there are 10 possible combinations of 2 jugglers juggling RR on both sides. (From combination theory, combinations with repetitions $(n+k-1)!/k!(n-1)!$ where $n = 4$ and $k = 2$).

No Passing Groups: - N3 (with 3), N4 (with 4) The N4 can be synchronous or asynchronous.

Passing Groups: R or L passing to, and then R or L receiving from (followed by number of objects if applicable)

Trivial patterns

N3 requires N4

3 3

N4 requires N3

(4 4) (note: can be in sync with either the left or right hand of the juggler with 3)

4 4

1-count patterns

$3p\ 3p\ | \ 4px\ 4px$

$3px\ 3px\ | \ 4p\ 4p$

RR requires RR

3 4p

3px 4

(4x 3p)

(3px 4)

LL requires LL

4p 3

4 3px

(3p 4x)

(4 3px)

LR requires RL

3p 4

3 4px

(3p 4)

(4x 3px)

RL requires LR

4 3p

4px 3

(4 3p)

(3px 4x)

Skewed patterns (4 clubs on one side and 3 clubs on the other)

RR3 requires RR4

3 3p

RR4 requires RR3

4px 4

(4px 4)

(4x 4p)

LL3 requires LL4

3p 3

LL4 requires LL3

4 4px

(4 4px)

(4p 4x)

RL3 requires LR4

3px 3

LR4

4p 4

(4p 4)

(4x 4px)

LR3 requires RL4

3 3px

RL4 requires LR3

4 4p

(4 4p)

(4px 4x)

58 total pattern combinations

More Patterns by Graham

More patterns by Graham Paasch

6 Club Dingle

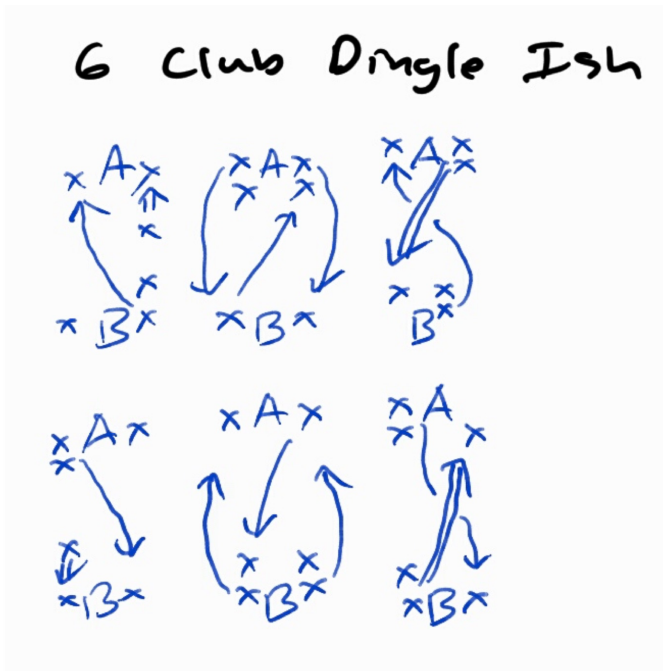

7 Club Dingle

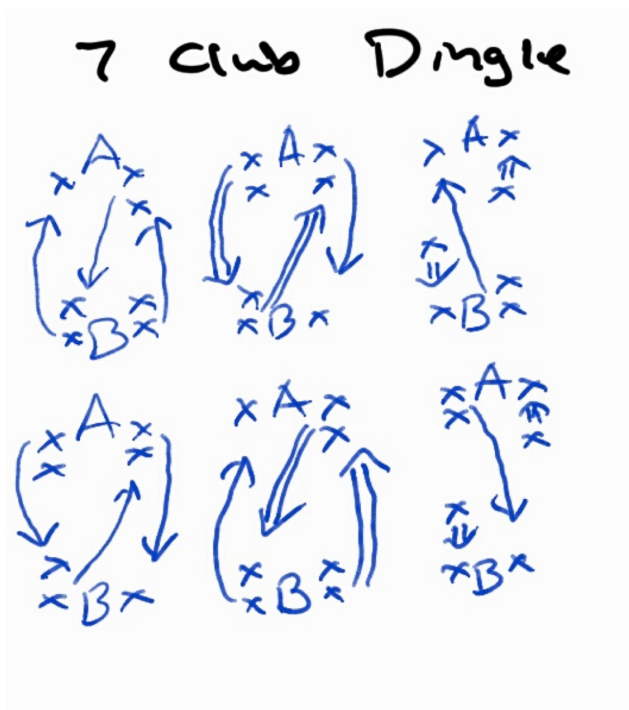

7 Club Martins

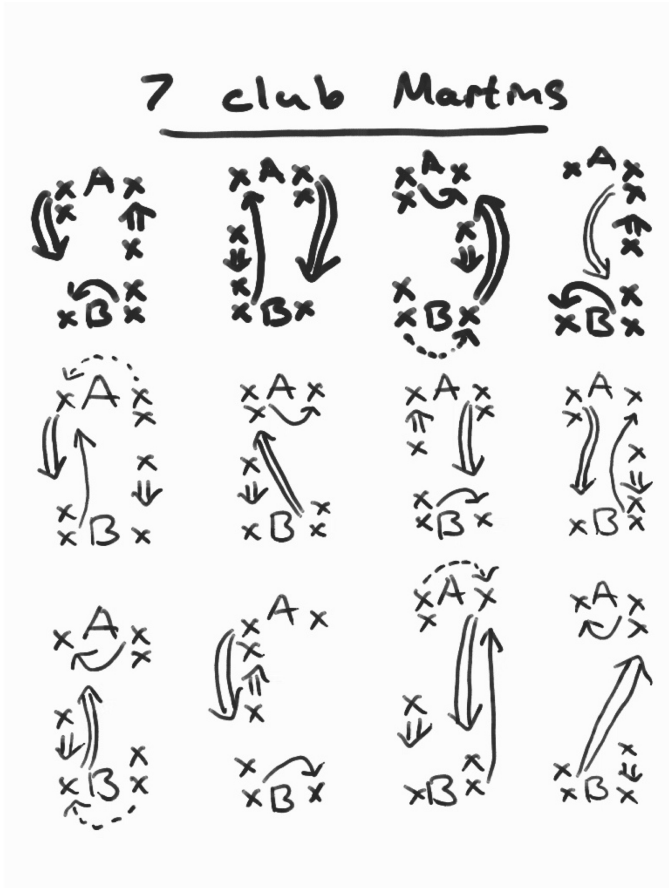

Hard 4 Person With Easy Positions

